

User Manual

Uninterruptible Power Supply System



TEOS 400 FLEX RT

3 phase In / 3 phase Out

10-30 kVA

INDUSTRIAL UPS



Please comply with all warnings and operating instructions in this manual. This equipment should only be installed, serviced, and maintained by qualified personnel. Do not operate this unit before reading through all safety information and operating instructions carefully.

Disclaimer

We assume no responsibility or liability for loss or damages, whether direct, indirect, consequential or incidental, which might arise out of the use of such information. The use of any such information will be entirely at the user's risk. Information in this manual is subject to change without notice. We make no commitment to update or keep current the information in this manual. If you find information in this manual that is incorrect, misleading, or incomplete, we would appreciate your comments and suggestions.



Table of Contents

1. SAFETY AND EMC INSTRUCTIONS	1
1-1. TRANSPORTATION AND STORAGE.....	1
1-2. PREPARATION.....	1
1-3. INSTALLATION.....	1
1-4.  CONNECTION WARNINGS.....	2
1-5. OPERATION.....	3
1-6. STANDARDS.....	3
2. INSTALLATION AND OPERATION	4
2-1. UNPACKING AND INSPECTION.....	4
2-2. WIRING TERMINAL VIEW.....	5
2-3. SINGLE UPS INSTALLATION.....	6
2-4. UPS INSTALLATION FOR PARALLEL SYSTEM.....	8
2-5. SOFTWARE INSTALLATION.....	9
3. OPERATIONS.....	10
3-1. BUTTON OPERATION.....	10
3-2. SCREEN DESCRIPTION.....	10
3-3. AUDIBLE ALARM.....	39
3-4. SINGLE UPS OPERATION.....	39
3-5. PARALLEL OPERATION.....	44
3-6. FAULT CODE.....	46
3-7. WARNING CODE.....	47
4. TROUBLESHOOTING	48
5. STORAGE AND MAINTENANCE.....	49
5-1. STORAGE.....	49
5-2. MAINTENANCE.....	49
6. SPECIFICATIONS	50





1. Safety and EMC instructions

All safety instructions in this document must be read, understood, and followed.









1-1. Transportation and Storage

-  Please transport the UPS system only in the original packaging to protect against shock and damage.
-  The UPS must be stored in the room where the temperature is well regulated. Ambient temperature should not exceed 40°C.

1-2. Preparation

-  Condensation may form if the UPS system is moved immediately from cold to warm environment. The UPS system must be absolutely dry before being installed. Please allow at least two hours for the UPS system to acclimate the environment.
-  Do not install the UPS system near water or in moist environments.
-  Do not install the UPS system where it would be exposed to direct sunlight or nearby heat source.
-  Do not block ventilation holes on the UPS housing.

1-3. Installation

-  Do not connect appliances or devices which would overload the UPS (e.g. big motor-type equipment)) to the UPS output terminal.
-  Place cables in such a way that no one can step on or trip over them.
-  Do not block air vents on the housing of the UPS. Ensure proper unit spacing of ventilation.
-  UPS came equipped with grounding terminal, in the final installation phase, connect grounding/earthing wire to the external UPS battery cabinets or appropriate grounding terminals.
-  The UPS can be installed only by qualified maintenance personnel.
-  An appropriate disconnect device such as short-circuit backup protection should be incorporated during installation.
-  An integral emergency shutoff switch which prevents additional load from the UPS in any mode of operation should be implemented during the installation.
-  Secure the grounding/earthing wire before connecting to any live wire terminal.
-  Installation and Wiring must be in accordance with the local electrical laws and regulations.

1-4. ⚠ Connection Warnings

- There is no standard backfeed protection inside of the UPS. However, there are relays on the Input to cut off line voltage and while the neutral is still connect to UPS.

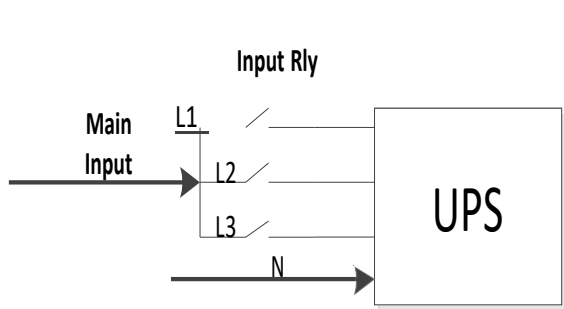

Input relay diagram

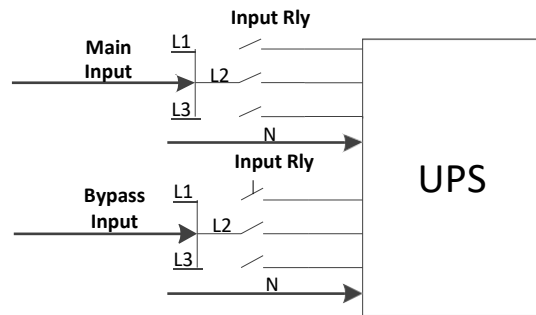

Input relay diagram for dual-input model

- This UPS should be connected with **TN** grounding/earthing system.
- The power input for this unit must be three-phase rated in accordance with the equipment nameplate. It also must be suitably grounded.

WARNING
HIGH LEAKAGE CURRENT
EARTH CONNECTION ESSENTIAL
BEFORE CONNECTING SUPPLY

- Use of this equipment in medical instrument of any life-sustaining equipment where failure of this equipment can reasonably be expected to cause the failure of the life-sustaining equipment or to significantly affect its safety or effectiveness is not recommended. Do not use this equipment in the presence of a flammable mixture with air, oxygen or nitrous oxide.
- Connect grounding terminal of UPS to a grounding electrode conductor.
- In accordance with safety standard EN-IEC 62040-1, installation has to be provided with a «Backfeed Protection» system, as for example a contactor, which will prevent the appearance of voltage or dangerous energy in the input mains during a mains fault (see figure 24 and respect the wiring diagram of «Backfeed Protection» depending if the equipment is with signal or three phase input).



There can be no derivation in the line that goes from the «Backfeed Protection» to the UPS, as the standard safety would be infringed.

- Warning labels should be placed on all primary power switches installed in places away from the unit to alert the electrical maintenance personnel of the presence of a UPS in the circuit. The label will bear the following or an equivalent text:

Before working on this circuit

- Isolate Uninterruptible Power Supply (UPS)
- Then check for Hazardous Voltage between all terminals including the protected earth

Risk of Voltage Backfeed

1-5. Operation



Do not disconnect the grounding/earthing conductor cable on the UPS or the building wiring terminals under any circumstance.



The UPS system features its own, internal current source (batteries). The UPS output sockets or output terminal blocks may be electrically live even if the UPS system is not connected to the building mains/live wires. (only for standard models)



In order to fully disconnect the UPS system, first press the "OFF" button and then disconnect the mains/live wires.



Ensure that no liquid or other foreign objects can enter into the UPS system.



The UPS can be operated by any individuals with no previous experience.

1-6. Standards

* Safety	
IEC/EN 62040-1	
* EMI	
Conducted Emission.	:IEC/EN 62040-2 Category C3
Radiated Emission	:IEC/EN 62040-2 Category C3
*EMS	
ESD	:IEC/EN 61000-4-2 CD Level 2 AD Level 3
RS	:IEC/EN 61000-4-3 Level 3
EFT	:IEC/EN 61000-4-4 Level 3
SURGE	:IEC/EN 61000-4-5 Level 3
CS	:IEC/EN 61000-4-6 Level 3
Power-frequency Magnetic field	:IEC/EN 61000-4-8 Level 4
Low Frequency Signals.....:IEC/EN 61000-2-2 10V	
Warning: This is a product for commercial and industrial application in the second environment-installation restrictions or additional measures may be needed to prevent disturbances.	

2. Installation and Operation

These series came with two VAC systems: 208V and 400V. Please refer to the following table.

VAC System	Model	Type
208V	LV 5KL/7.5KL/10KL/15KL	Long-run model
400V	HV 10KL/15KL/20KL/30KL	

We also offer optional parallel function for both models upon request. The UPS with parallel function is called the "Parallel model". We have detail installation and operation procedure of the Parallel Model in the following chapter.

2-1. Unpacking and Inspection

Unpack the package and check the package contents. The shipping package should contain:

- One UPS
- One user manual
- One monitoring software CD
- One RS-232 cable (option)
- One USB cable
- One parallel cable (only available for parallel model)
- One shared current cable (only available for parallel model)

NOTE: Before the installation, please inspect the unit. Be sure that there is no physical damage to the unit. Do not turn on the unit and notify the carrier and dealer immediately if there is any damage or missing parts and accessories. Please keep the original packaging for future use. It is recommended to keep each equipment and battery set in their original packaging because they have been designed to provide maximum protection during transportation and storage.

2-2. Wiring Terminal View

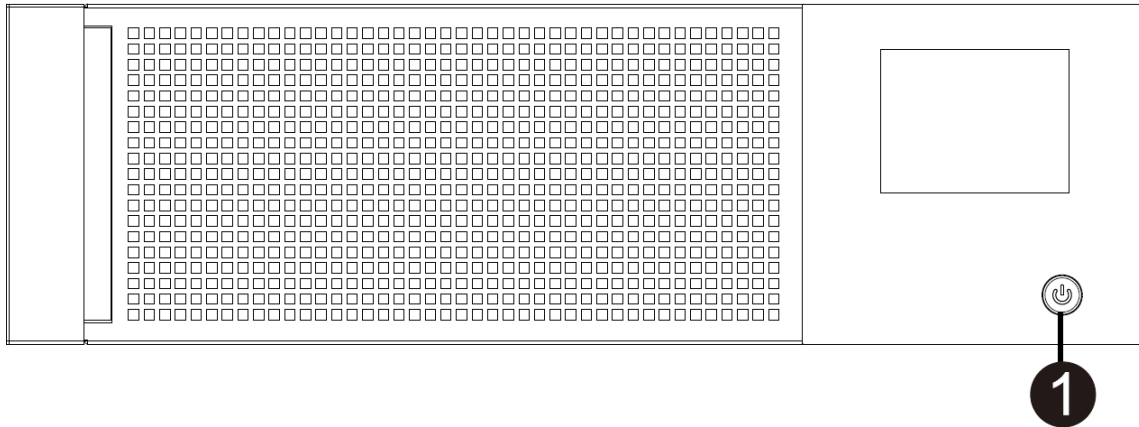

Diagram 1: Front panel

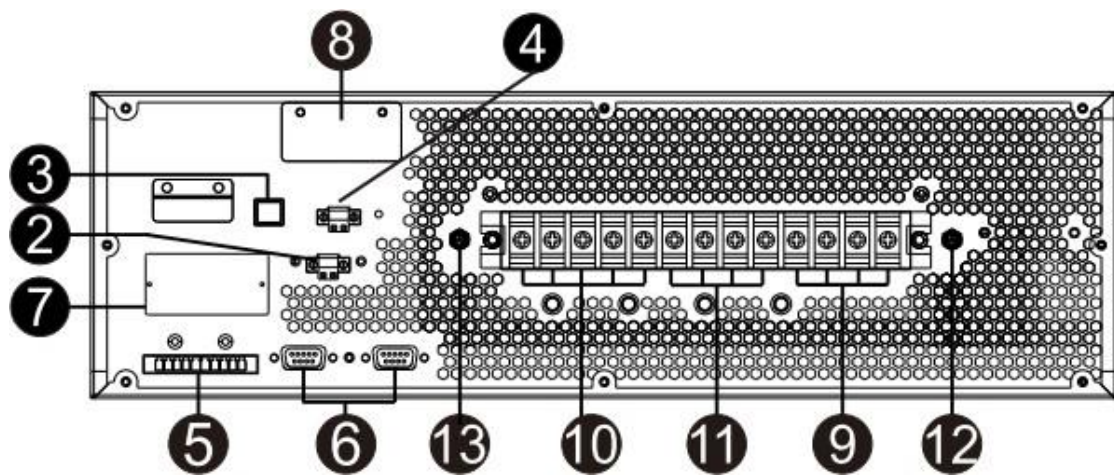

Diagram 2: HV10KL/LV5KL Rear Panel

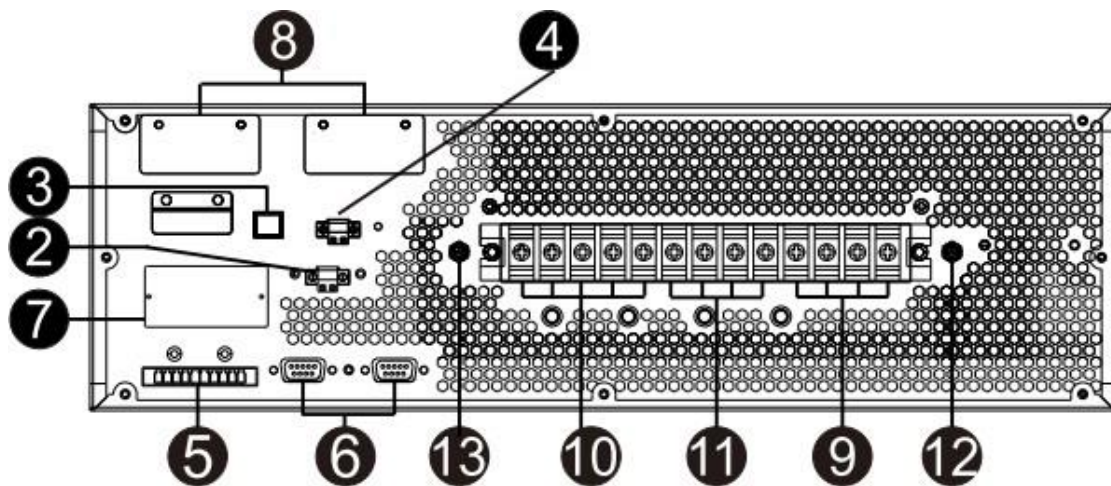

Diagram 3: HV15KL/HV20KL/LV7.5KL/LV10KL

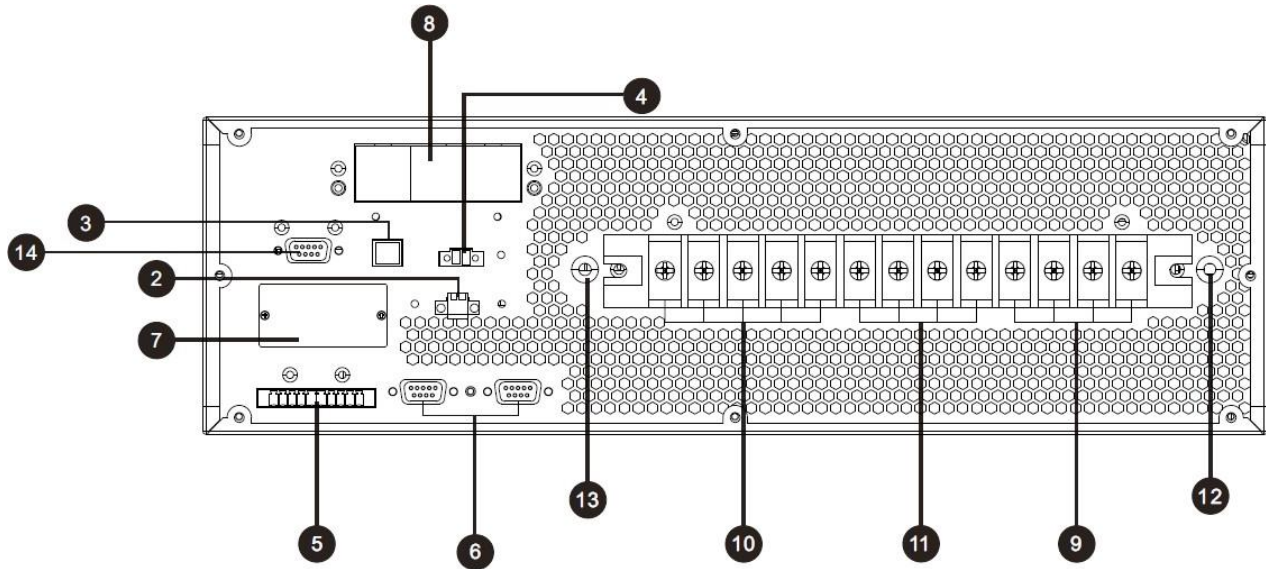

Diagram 4: HV30KL/LV15KL

1. Power switch
2. External maintenance bypass switch port
3. USB communication port
4. Emergency power off function connector (EPO connector)
5. Share current port (only available for parallel model)
6. Parallel port (only available for parallel model)
7. Intelligent slot
8. External battery connector
9. Line input terminal
10. Output terminal
11. Bypass input terminal
12. Input grounding terminal
13. Output grounding terminal
14. RS232 Port

2-3. Single UPS Installation

Installation and wiring must be carried out in accordance with the local electric laws and regulations by trained professionals.

- 1) Make sure that the mains wire and breakers of the building are rated for the capacity of the UPS to prevent electric shock or risk of fire.

NOTE: Do not use the wall receptacle as the input power source for the UPS, as its rated current is less than the UPS’s maximum input current. The receptacle may be damaged and destroyed.

- 2) Switch off the mains switch in the building before installation.
- 3) Turn off all the connected devices before connecting to the UPS.
- 4) Prepare wires based on the following table:

Model	Wiring spec (AWG)					
	Input(Ph)	Bypass(Ph)	Output(Ph)	Neutral	Battery	Ground
HV 10KL 33 /LV 5KL 33	14	14	14	10	8	8
HV 10KL 31/LV 5KL 31	14	8	8	8		8
HV 15KL 33 / LV 7.5KL 33	12	12	12	10	8	8
HV 15K 31/LV 7.5K 31	12	6	6	6		6
HV 20KL 33/ LV 10KL 33	10	10	10	6	8	6
HV 20KL 31/LV 10KL 31	10	4	4	4		4
HV 30KL / LV 15KL	8	8	8	4	6	4

NOTE : The selections for color of wires should be followed by the local electrical laws and regulations.

5) Remove the terminal block cover at the rear panel of UPS. Then connect the wires according to the following terminal block diagrams: (Connect the grounding/earthing wire first when making other wire connections. Remove the grounding/earthing wire last when connecting the UPS!)

NOTE: For dual input model with single input power system, connect input terminals to the AC power source and connect input and bypass input together (shows dashed line in below wiring diagrams)

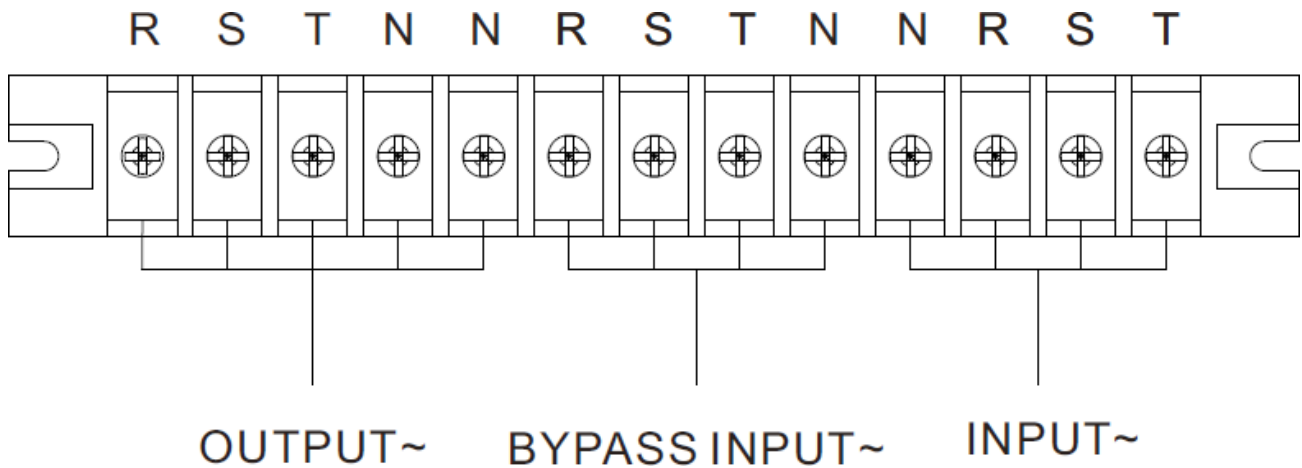

Terminal block wiring diagram for 33 HV10K(L)/15K(L)/20K(L)/30K(L) and 33 LV 5K(L)/7.5K(L)/10K(L)/15K(L)

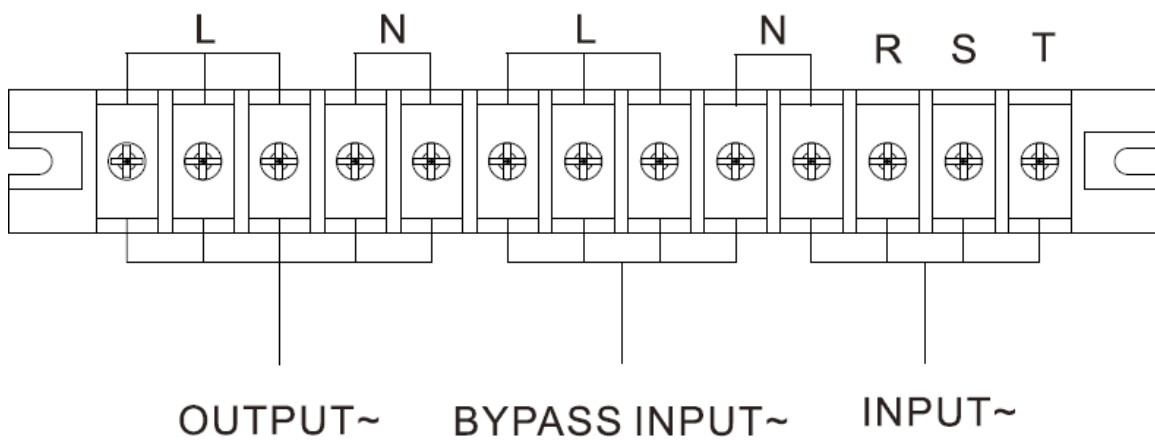

Terminal block wiring diagram for 31 HV10K(L)/15K(L)/20K(L) and 31 LV 5K(L)/7.5K(L)/10K(L)

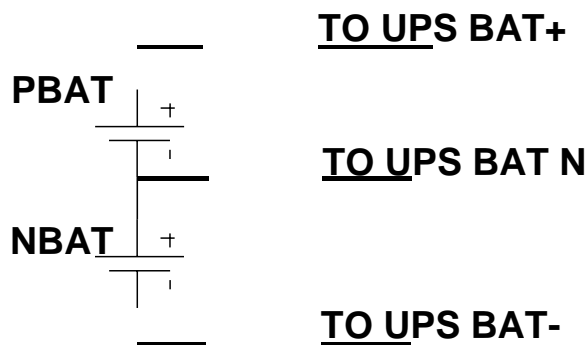

Battery wires connection schematic

NOTE 1: Make sure that the wires are connected securely with the terminals.

NOTE 2: Please install the output breaker between the output terminal and the load, and the breaker should have leakage current protective function if necessary.

6) Put the terminal block cover back at the rear panel of the UPS.



Warning:

- Make sure a DC breaker or other protective device between UPS and the external battery pack is installed for added safety. If not, please install it carefully. Switch off the battery breaker before installation.

NOTE: Set the battery pack breaker in "OFF" position and then install the battery pack.

- Pay special attention to the rated battery voltage marked on the rear panel. If you want to change the numbers of the battery in a chain, make sure you modify the UPS setting accordingly. Connection with wrong battery voltage may cause irreversible damage of the UPS.
- Pay special attention to the polarity marking on external battery terminal block. Connection with wrong battery voltage may cause irreversible damage of the UPS.
- Make sure the protective grounding/earthing wiring is adequate. The current spec, color, position, connection and conductance reliability of the wire should be verified.
- Make sure the utility input & output wiring is rated correctly. The current spec, color, position, connection and conductance reliability of the wire should be verified. Make sure the L/N side is correct, not reverse or short-circuited.

2-4. UPS Installation for Parallel System

If the UPS is only for single operation, you may skip this section.

- 1) Install and wired the UPS according to the section 2-3.
- 2) Connect the output wires of each UPS to an output breaker.
- 3) Connect all output breakers to a major breaker. This major output breaker will then connect directly to the loads.
- 4) Either common battery packs or independent battery packs for each UPS are allowed.
- 5) Refer to the following wiring diagram:

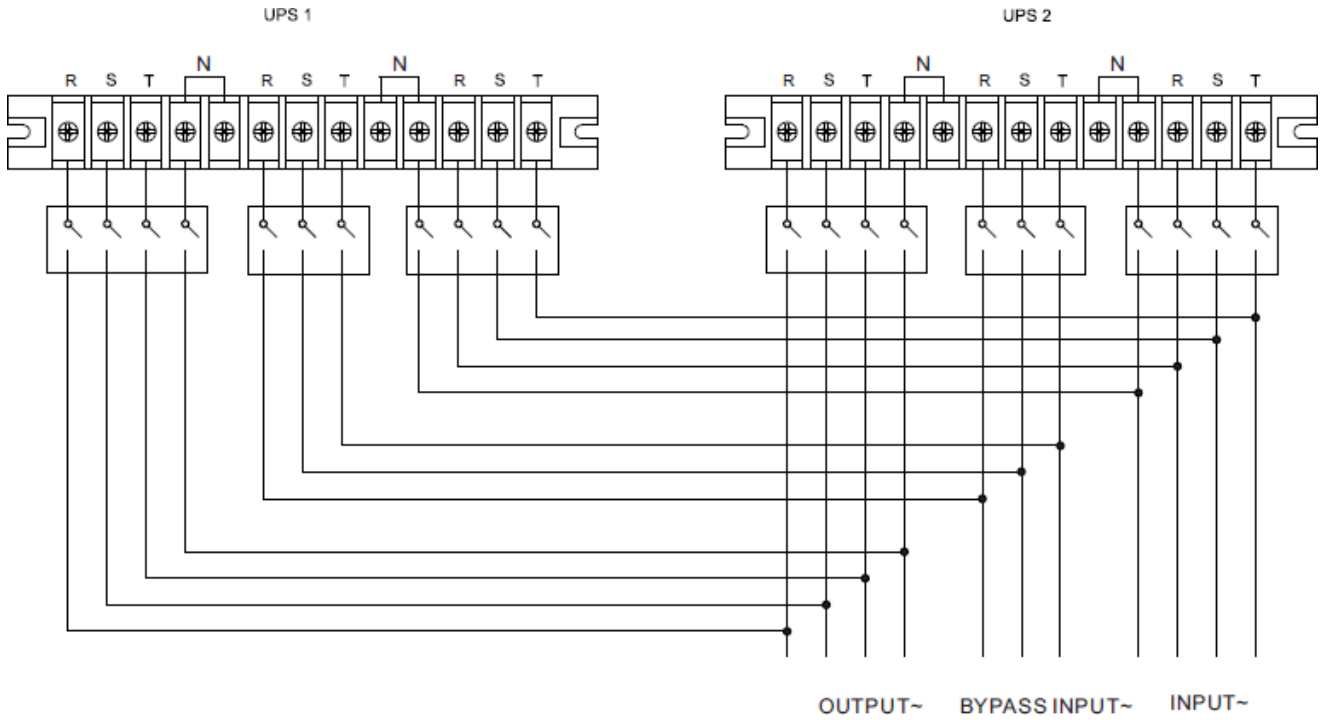

Wiring diagram of parallel system for 33 HV10K(L)/15K(L)/20K(L)/30K(L) and 33 LV5K(L)/7.5K(L)/10K(L)/15K(L)

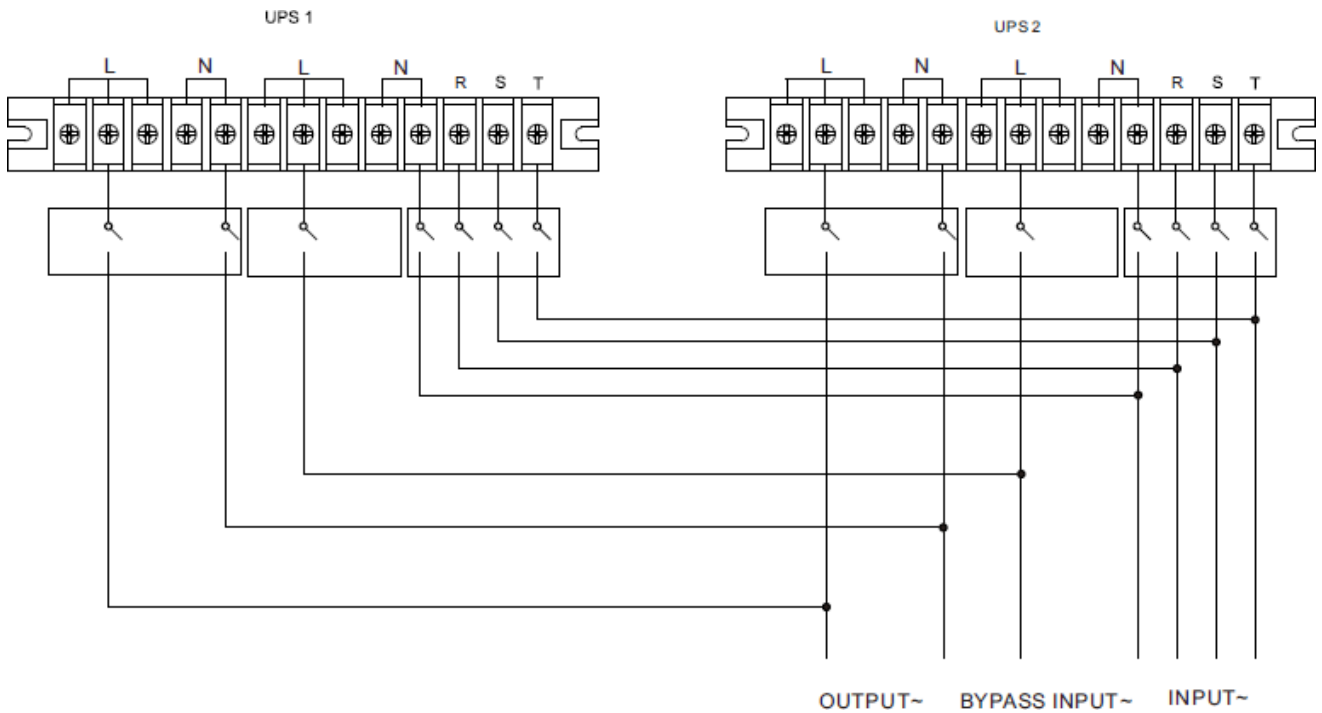

Wiring diagram of parallel system for 31 HV10K(L)/15K(L)/20K(L) and 31 LV5K(L)/7.5K(L)/10K(L)

2-5. Software Installation

For optimal computer system protection, install UPS monitoring software to configure UPS shutdown operation.

3. Operations

3-1. Button Operation

- 1) Before operation, make sure that the two strings of batteries are connected correctly in order of "+,GND,-" terminals and the breaker of the battery pack is at "ON" position (only for long-run model).
- 2) Press the "POWER" button to set up the power supply for the UPS. UPS will enter into power on mode. After initialization, UPS will enter into "No Output mode".

3-2. Screen Description

After initialization, the LCD will display main screen. There are five sub-menus: Control, measure, setting, information and data log. Touch any sub-menu icon to enter into the sub-screen.

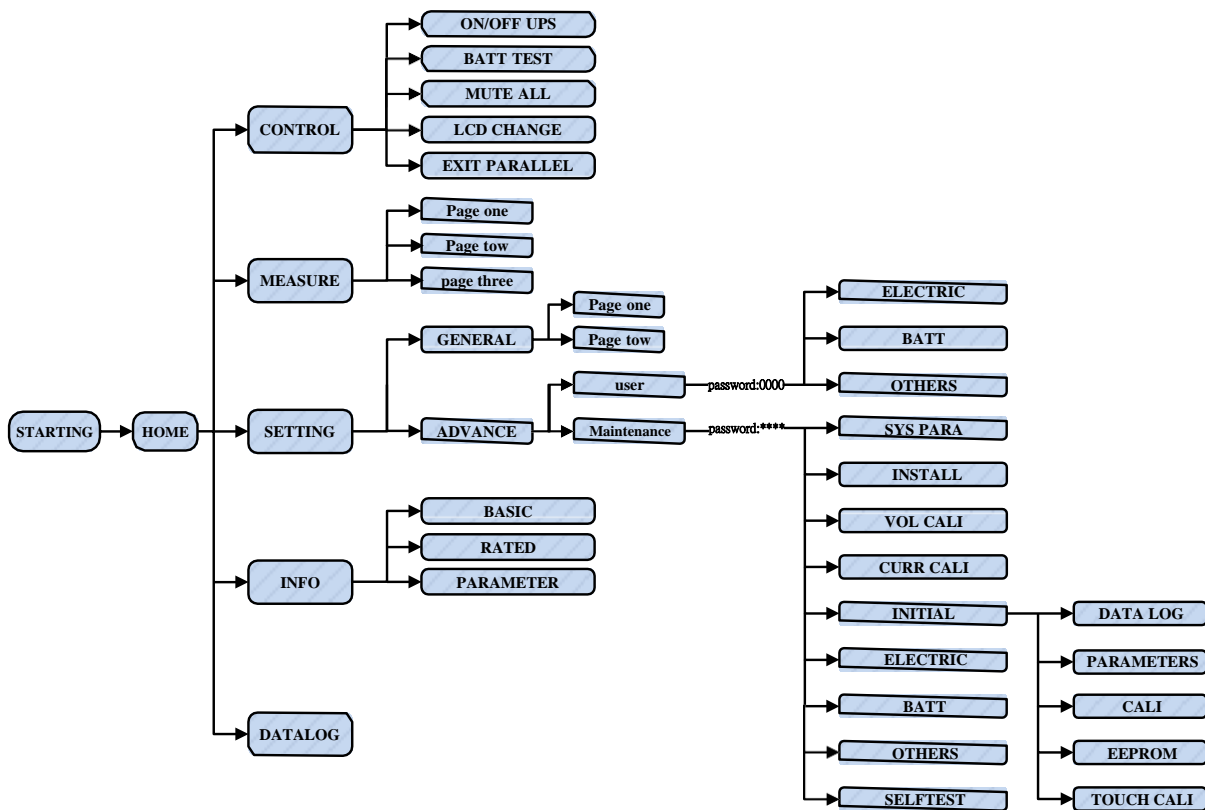

Menu tree

3-2-1. Main screen

Upon powering on, the LCD will start initialization approximately few seconds as shown below.



After initialization, the main screen will display as shown below.

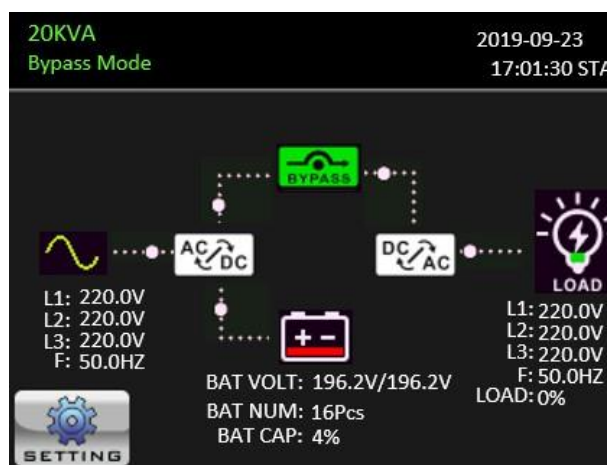



After touching the  icon, it will show five icons in center to represent five sub-menus: Control, measure, setting, information, data log.

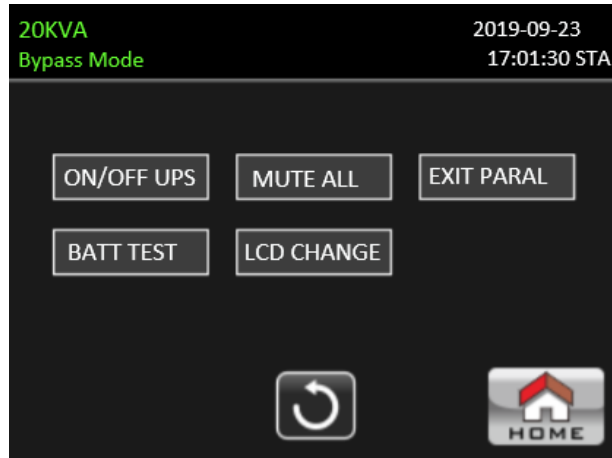

3-2-2. Control screen

Touch the icon  to enter control sub-menu.



Touch  icon will return back to main screen no matter it's in any screen of any submenu.

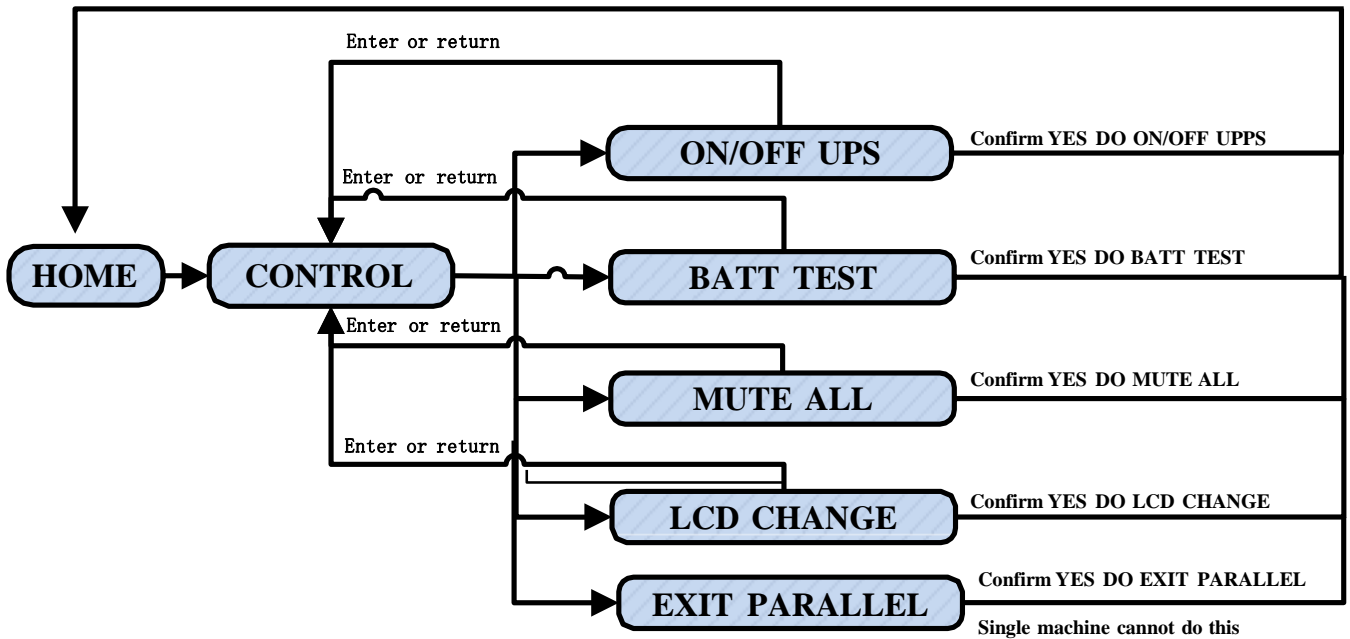

Screen 1.0 «Control» and its sub-menus

➤ **On/Off UPS**

It will show "On UPS?" when UPS is off.

It will show "Off UPS?" when UPS is on.

Touch "YES" to turn on or off the UPS. Then, the screen will return to main screen.

Touch "Back" to return to main screen immediately or "No" to cancel this operation and back to main screen.

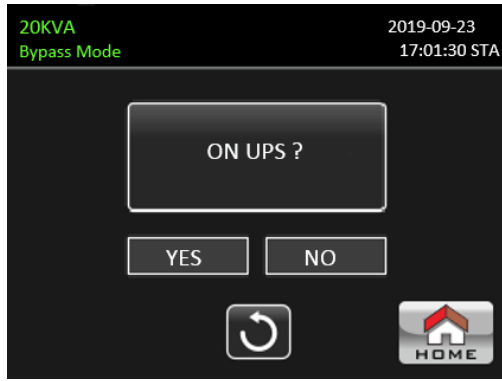

TURN ON UPS

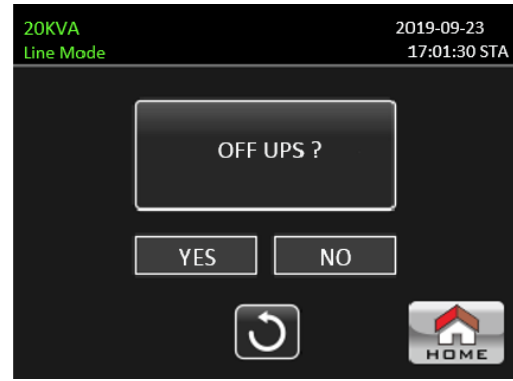

TURN OFF UPS

➤ **Battery Test**

It will show "Start Battery Test" if the UPS is not in test. Touch "Yes" to start battery test. Then, it will start battery testing. After few seconds, battery test result will show on the screen. Touch "Back" to return to main screen immediately or "No" to cancel this operation and back to main screen.

It will show "Stop battery test" if the UPS is in test.

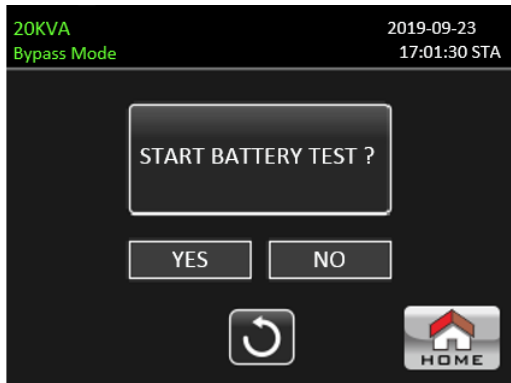

Battery Test

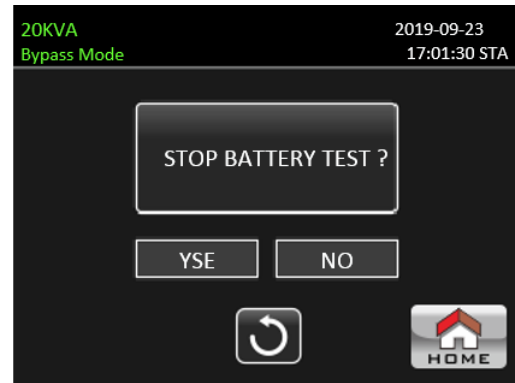

Cancel Battery Test

➤ **Mute All**

It will show "Mute all" if the audio is active. Touch "Yes" to activate mute. If "Mute all" is active, it will show  icon on the top left corner of the main screen. Touch "Back" to return to CONTROL screen immediately or "No" to cancel this operation and back to CONTROL screen.

It will show "Cancel mute all" if the UPS is mute already. Touch "Yes" to activate audio function or "No" keep mute. Touch "HOME" will return to CONTROL screen.

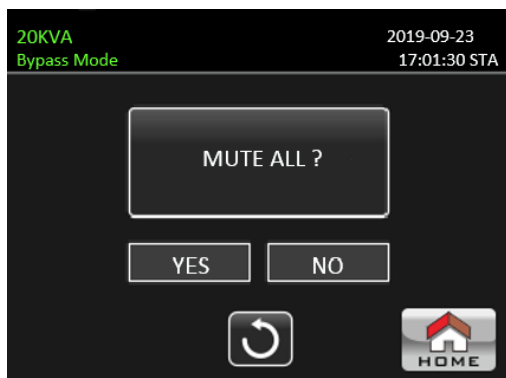

Mute All

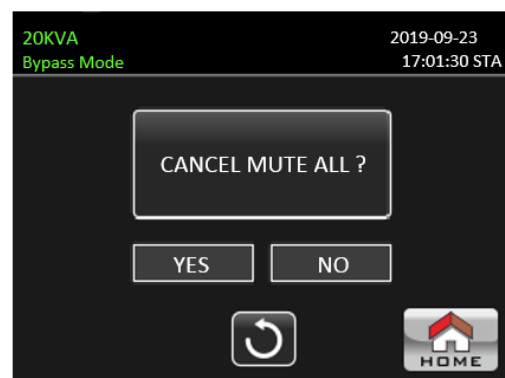

Cancel Mute all

➤ **LCD Change**

When LCD is in "Rack Display", if you touch "LCD Change" icon, it will pop-up "Tower Display" window.

When LCD is in "Tower Display", if you touch "LCD Change", it will pop-up "Rack Display" window.

Touch "Yes" icon to change LCD Display.

Touch "No" icon to cancel this operation and back to CONTROL screen.

Touch "HOME" to return to main screen.

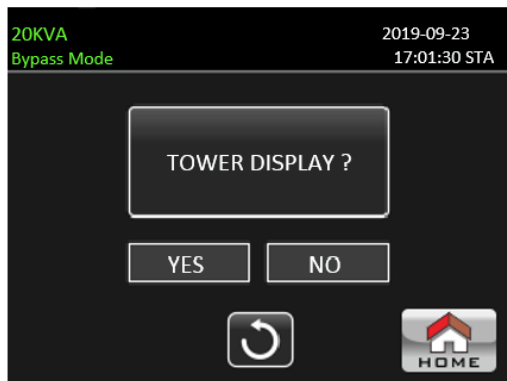

Tower Display

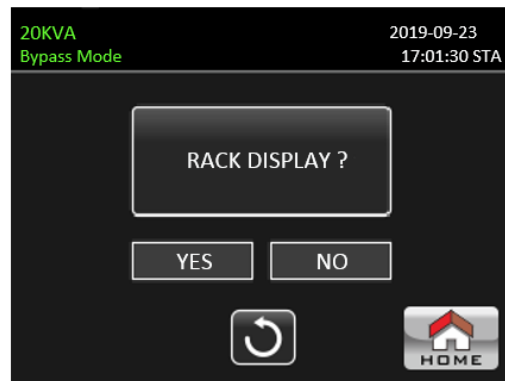

Rack Display

➤ **Exit Parallel**

If the UPS is set as parallel mode, you can touch this icon to stop parallel mode.

Touch "Yes" to stop parallel mode and enter into standby mode.

Touch "No" to cancel this operation and back to CONTROL screen.

If the UPS is operated in single mode, even you touch this icon, it will pop-up "This mode can't be setup" window.

Touch "HOME" to return to main screen.





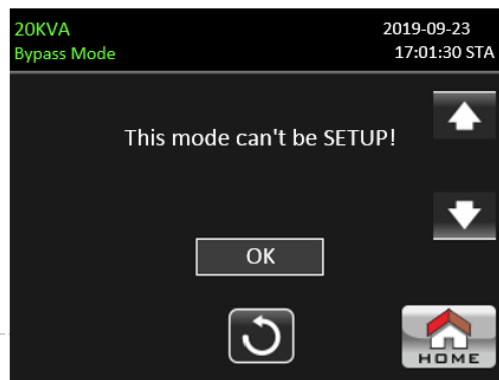

Exit Parallel



This mode can't be setup

3-2-3. Measure screen

Touch the icon  to enter measure page. Touch the icon  or  to browse information. Touch the icon  to return to main screen. Touch the icon  to go back to previous menu.

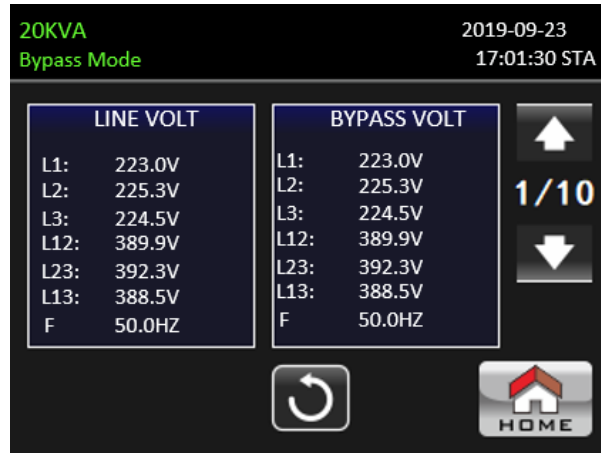

Measure screen page 1

- LINE VOLT: The real time value of L1, L2 and L3 phase voltage, L1L2/L2L3/L3L1 voltage and input frequency.
- BYPASS VOLT: The real time value of L1, L2 and L3 bypass voltage, L1L2/L2L3/L3L1 voltage and frequency.

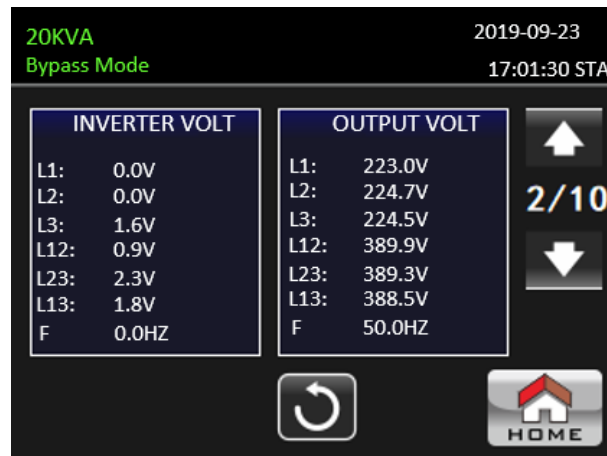

Measure screen page 2

- INVERTER VOLT: The real time value of L1, L2 and L3 inverter voltage, L1L2/L2L3/L3L1 voltage and frequency.
- OUTPUT VOLT: The real time value of L1, L2 and L3 output voltage, L1L2/L2L3/L3L1 voltage and frequency.

20KVA		2019-09-23
Bypass Mode		17:01:30 STA
INPUT W	INPUT W %	↑ 3/10 ↓
L1: 7W	0%	
L2: 2W	0%	
L3: 3W	0%	
TOTAL W %	0%	

Measure screen page 3

- INPUT W: L1, L2 and L3 input power in watt.
- INPUT W (%): L1, L2 and L3 input power watt in percentage.

20KVA		2019-09-23
Bypass Mode		17:01:30 STA
INPUT VA	INPUT VA %	↑ 4/10 ↓
L1: 57VA	0%	
L2: 67VA	1%	
L3: 67VA	1%	
INPUT VA %	0%	

Measure screen page 4

- INPUT VA: L1, L2 and L3 input power in VA.
- INPUT VA (%): L1, L2 and L3 input power VA in percentage.

20KVA		2019-09-23
Bypass Mode		17:01:30 STA
OUTPUT W	OUTPUT W %	↑ 5/10 ↓
L1: 6W	0%	
L2: 2W	0%	
L3: 3W	0%	
TOTAL W %	0%	

Measure screen page 5

- OUTPUT W: L1, L2 and L3 output power in watt.
- OUTPUT W (%): L1, L2 and L3 output power watt in percentage.

20KVA		2019-09-23
Bypass Mode		17:01:30 STA
OUTPUT VA	OUTPUT VA %	
L1: 67VA	0%	↑ 6/10 ↓
L2: 67VA	1%	
L3: 67VA	1%	
TOTAL VA %	0%	

Measure screen page 6

- OUTPUT VA: L1, L2 and L3 output power in VA.
- OUTPUT VA (%): L1, L2 and L3 output power VA in percentage.

20KVA		2019-09-23
Bypass Mode		17:01:30 STA
INPUT CURR	INPUT PF	
L1: 0.3A	0.04	↑ 7/10 ↓
L2: 0.3A	0.04	
L3: 0.3A	0.04	

Measure screen page 7

- INPUT CURR: L1, L2, L3 input current in Amp.
- INPUT PF: L1, L2, L3 input power factor.

20KVA		2019-09-23
Bypass Mode		17:01:30 STA
OUTPUT CURR	OUTPUT PF	
L1: 0.3A	0.13	↑ 8/10 ↓
L2: 0.3A	0.04	
L3: 0.3A	0.07	

Measure screen page 8

- OUTPUT CURR: L1, L2, L3 output current in Amp.
- OUTPUT PF: L1, L2, L3 output power factor.

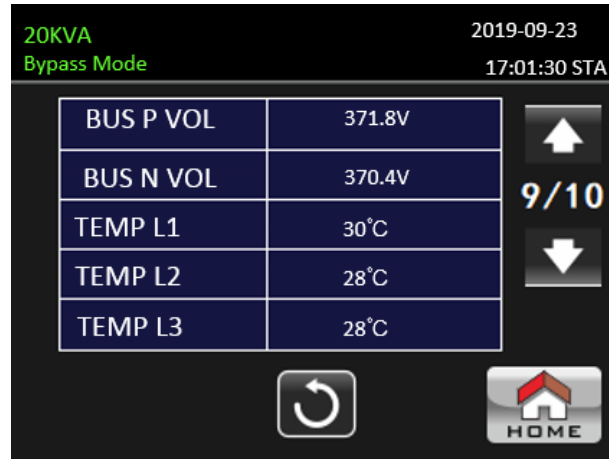

Measure screen page 9

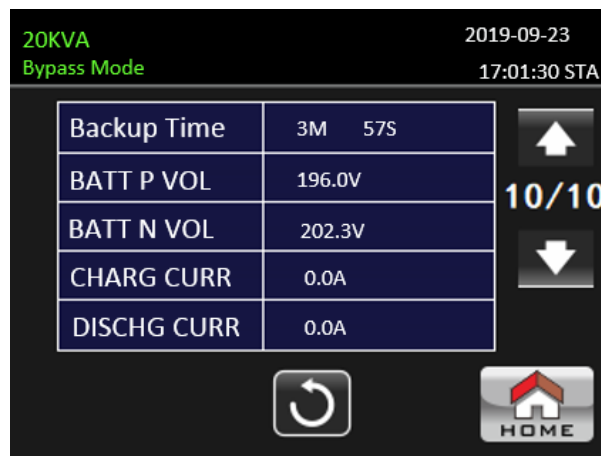

- BUS Voltage: The real time value of DC BUS (P and N) voltage.
- TEMP: Temperature of PFC, INV and BYP.



Measure screen page 10

- Backup Time: Estimated discharge time.
- BATT Voltage /Charging Current/Discharging Current: The real time value of DC related information.

3-2-4. Setting screen

This sub-menu is used to set the parameters of UPS. Touch the icon  to enter setting menu page. There are 2 options: General and Advanced. Touch the icon  to return to main screen. Touch the icon  to go back to previous menu.

NOTE: Not all settings are available in every operation mode. If the setting is not available in present mode, the LCD will keep its original setting parameter showed instead of changing the parameters.

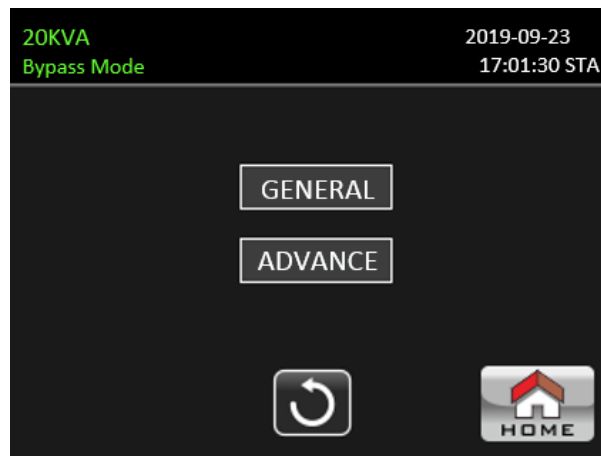

Setting screen

- **GENERAL:** It's to set up basic information of the UPS. It's not related to any function parameter.
- **ADVANCE:** It's required to enter password to access to the "ADVANCED" setting. There are two types of authority, User and Maintainer.

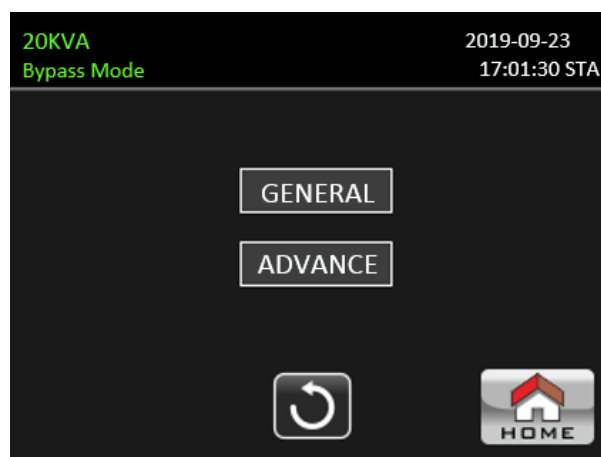

General Setting

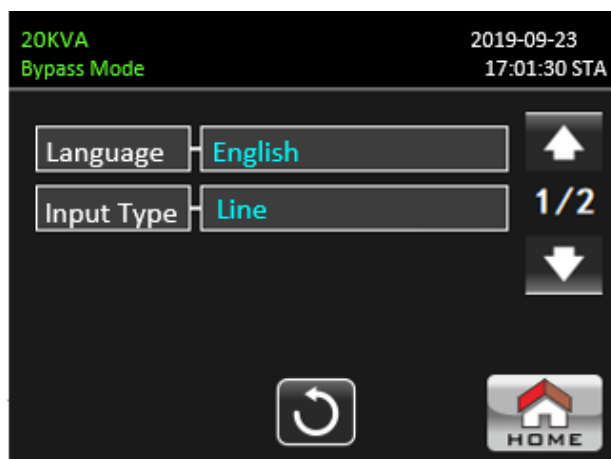

Setting screen page 1

- **Language:** Set the LCD language. There are three options: English, Simplified Chinese and Traditional Chinese. English is default setting.
- **Input Source:** Select the input source. There are two options: Line (utility) and generator. Line is default setting. This setting value will show on the main page. When "generator" is selected, the acceptable input frequency will be fixed at the range of 40~70Hz. This setting value will show on the status bar.

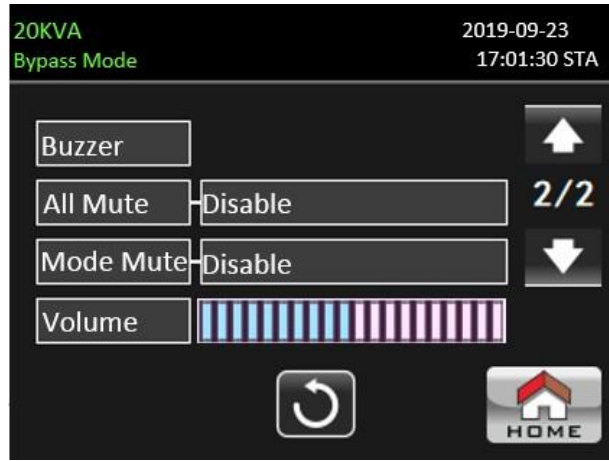

Setting screen page 2

- **Buzzer:** if you touch this icon, it will pop-up "Yes" and "No" option. If you touch "Yes", it will turn off the warning buzzer. If you touch "No", it will turn on the warning buzzer. The factory default setting is turn on the warning buzzer
- **All Mute:**
 Disable: When selected, the UPS will alarm when warning occurs. Enable: When selected, the UPS will NOT alarm when warning occurs.
- **Mode Mute:**
 Disable: When selected, the UPS will alarm when UPS related status changes. Enable: When selected, the UPS will NOT alarm when UPS related status changes.
- **Volume:**
 Simply touch the panel to adjust alarm volume.

Advance Setting

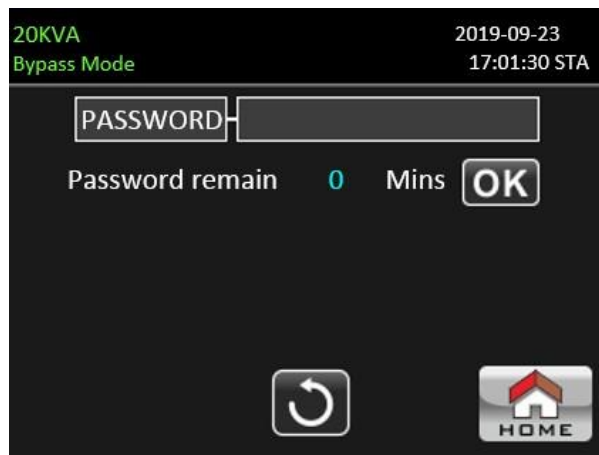

Advance Password Page

- Advance → User
 To access to the "Advance→User" Setting menu page, it's required to enter the default password "0000". If entered password is right, the page will jump to setting screen. If the password is wrong, it will ask to enter again.

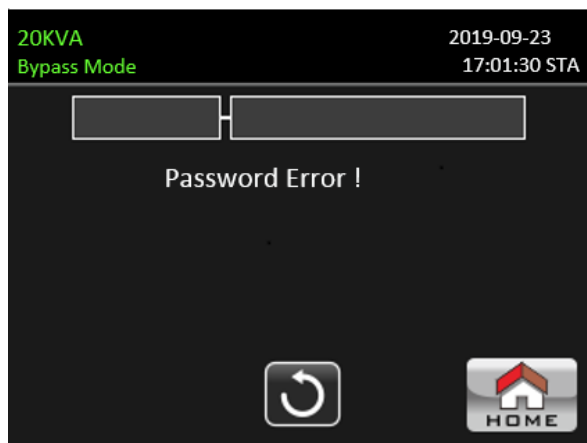

Password error page

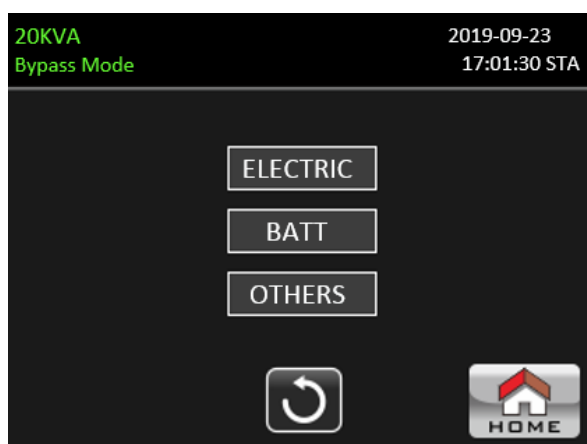

Advance Setting Menu Page

There are three sub-menus under "Advance→User" setting: ELECTRIC, BATT and OTHERS.

ELECTRIC

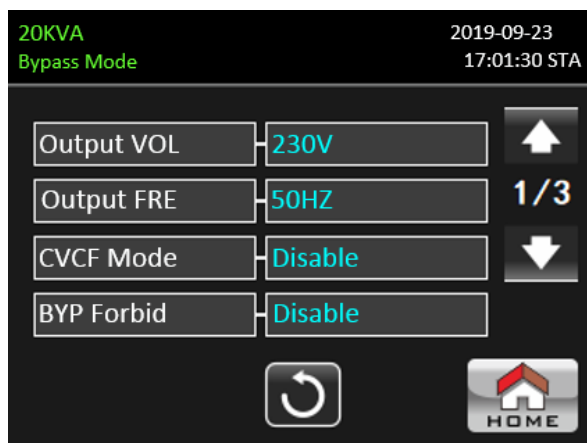

Electric Setting Page 1

- Output VOL.: Select the output rated voltage.
 - If the UPS is HV system, there are four options, 208V, 220V, 230V and 240V.
 - If the UPS is LV system, there are two options, 120V and 127V.
- Output Frequency. Select output rated frequency.
 - **50Hz:** The output frequency is setting for 50Hz.
 - **60Hz:** The output frequency is setting for 60Hz.
- CVCF Mode (constant voltage and constant frequency function)
 - **Enable:** CVCF function is enabled. The output frequency will be fixed at 50Hz or 60Hz according to setting of "OP Freq.". The input frequency could be from 40Hz to 70Hz.
 - **Disable:** CVCF function is disabled. The output frequency will synchronize with the bypass

frequency within 45~55 Hz for 50Hz system or within 55~65 Hz for 60Hz system. Disable is the default setting.

➤ Bypass Forbid:

- **Enable:** Bypass forbid is allowed. When selected, it's not allowed for running in Bypass mode under any situations.
- **Disable:** Bypass forbid is not allowed. When selected, UPS will run in Bypass mode depending on "Bypass at UPS off" setting. It is the default setting.

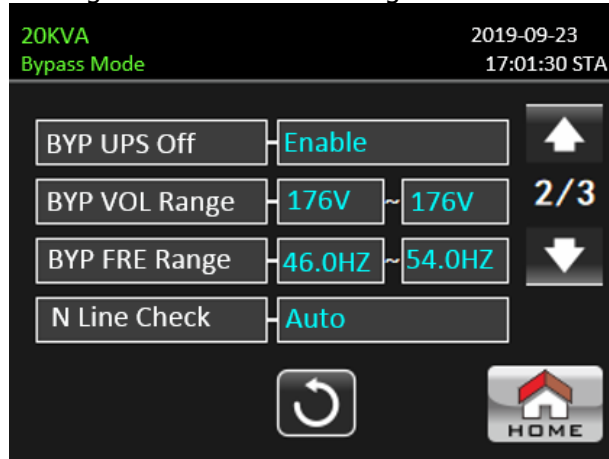

Electric Setting Page 2

➤ Bypass at UPS off: Select the bypass status when manually turning off the UPS. This setting is only available when "Bypass forbid." is set to "Disable".

- **Enable:** Bypass enabled. When selected, bypass mode is activated.
- **Disable:** Bypass disabled. When selected, no output through bypass when manually turning off the UPS.

➤ Bypass Voltage Range: Set the bypass voltage range.

- **L:** Low voltage point for bypass. The setting range is 176V ~ 209V when UPS is HV system. The setting range is 96V ~ 110V when UPS is LV system.
- **H:** High voltage point for bypass. The setting range is 231V ~ 264V when UPS is HV system. The setting range is 130V ~ 146V when UPS is LV system.

➤ Bypass Frequency Range: Set the bypass frequency range.

The acceptable bypass frequency range from 46Hz to 54Hz when UPS is 50Hz system and from 56Hz to 64Hz when UPS is 60Hz system.

➤ N Line Check: Check if neutral line is correctly connected or not.

- **Disable:** Disable the neutral loss detection function. The UPS will not detect the neutral loss or not.
- **Auto:** The UPS will automatically detect the neutral is lost or not. If neutral loss is detected, an alarm will be generated. If the UPS is turned on, it will transfer to battery mode. When neutral is restored and detected, the alarm will be muted automatically and the UPS will go back to normal mode automatically.
- **CHE:** The UPS will detect the neutral loss or not only when first commission. If neutral loss is detected, an alarm will be generated. If the UPS is turned on, it will transfer to battery mode. When neutral is restored, the alarm will NOT be muted automatically and the UPS will NOT go back to normal mode automatically. Please be sure to enter this selection and re-start the UPS again to mute alarm.

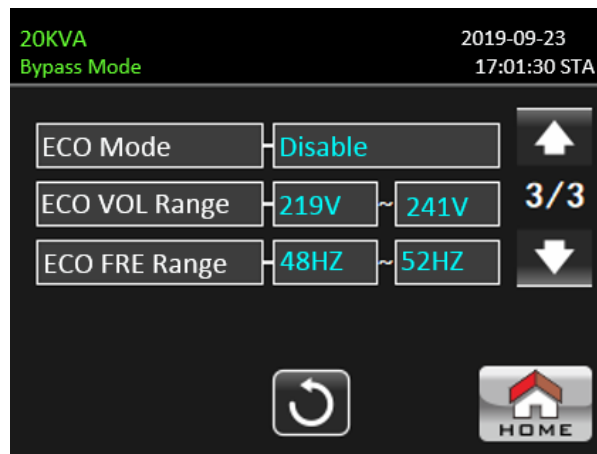

Electrical Setting Page 3

- ECO mode: Enable/Disable ECO mode. Default setting is "Disable".
- ECO Voltage Range: Set the ECO voltage range.
 - **L:** Low voltage point for ECO mode. The setting range is from (Rated output voltage – 5V) to (Rated output voltage - 11V). "Rated output voltage – 5V" is default setting.
 - **H:** High voltage point for ECO mode. The setting range is from (Rated output voltage + 5V) to (Rated output voltage + 11V). "Rated output voltage + 5V" is default setting.
- ECO Frequency Range: Set the ECO frequency range. The setting range is from 46Hz to 54Hz when the UPS is 50Hz system and from 56Hz to 64Hz when the UPS is 60Hz system.

BATT

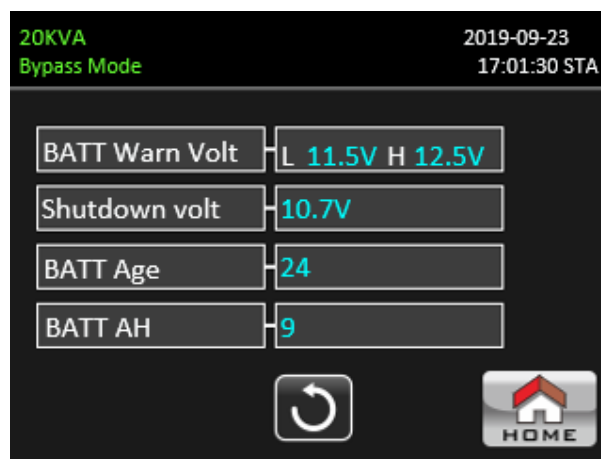

Battery setting page

- Battery Warning Voltage:
 - **HIGH:** High battery warning voltage. The setting range is 14.0V ~ 15.0V. 14.4V is default setting.
 - **LOW:** Low battery warning voltage. The setting range is 10.1V ~ 14.0V. 11.4V is default setting. This parameter setting is related to "Shutdown Voltage" setting. This setting value should be higher than "Shutdown Voltage" setting.
- Shutdown Voltage: If battery voltage is lower than this point in battery mode, UPS will automatically shut down. The setting range is 10.5V ~ 12V. 10.7V is default setting.
- Battery age: if battery age is beyond the setting month, then the UPS will alarm for reminding. The factory default setting is 24 months.
- Battery AH: Setting battery capacity

OTHERS

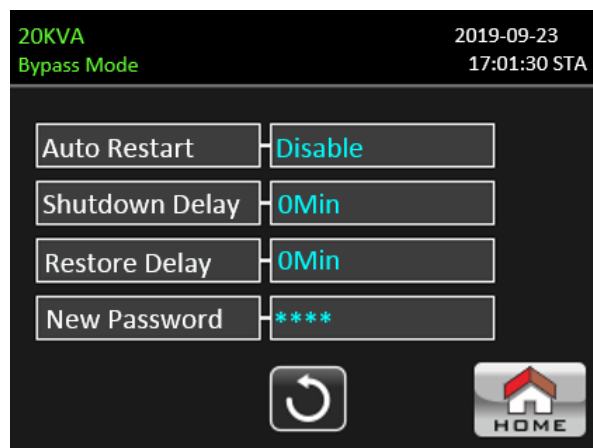

OTHERS setting page

- Auto Restart:
 - **Enable:** After "Enable" is set, once UPS shutdown occurs due to low battery and then utility restores, the UPS will return to line mode.
 - **Disable:** After "Disable" is set, once UPS shutdown occurs and the utility restores, the UPS will not automatically turn on.
- Shutdown Delay: UPS will shut down in setting minutes. The countdown will start after confirming the pop-up screen.
- Restore Delay: UPS will automatically restart in setting minutes after the UPS shuts down.
- New Password: Set up new password to enter "ADVANCE➔ User" menu.

ADVANCE ➔ Maintainer

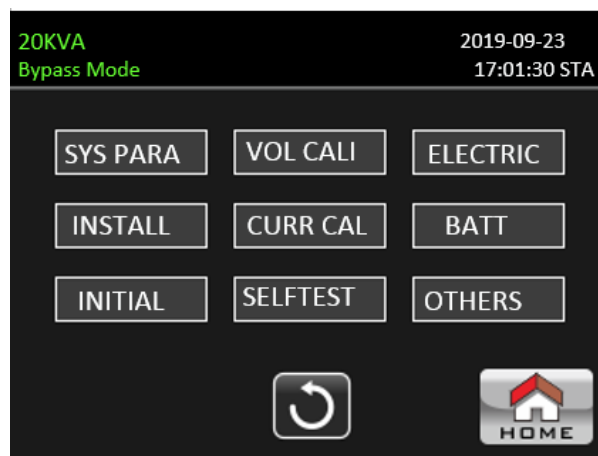

Advance➔ Maintainer Setting Menu

To access the "Advance➔Maintainer" Setting menu page, it's required to enter password. Please contact your local dealer to get maintainer password.

CAUTION: This setting menu is only for qualified technician. Otherwise, mis-operation will cause UPS damage.

There are 9 sub-menus under "Advance➔Maintainer" setting: SYS PARAMETER, INSTALL, INITIAL, VOL CALI, CURR CALI, SELF TEST, ELECTRIC, BATT and OTHERS.

SYSTEM PARAMETER

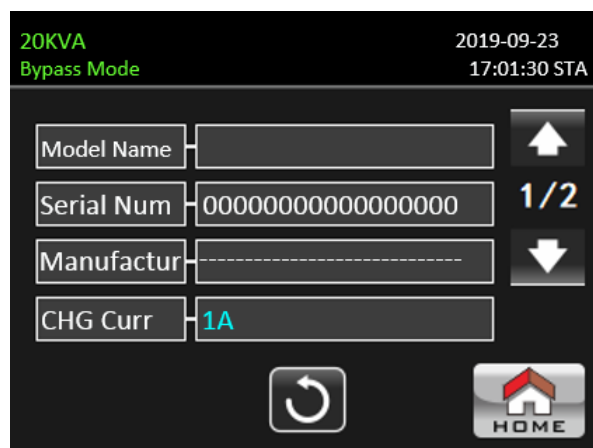

SYSTEM PARAMETER Page 1

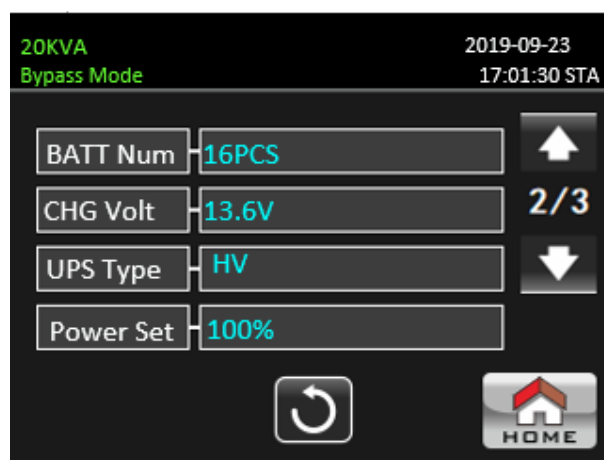

SYSTEM PARAMETER Page 2

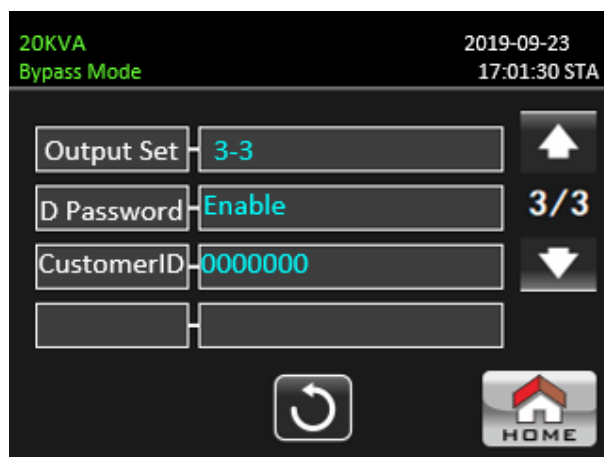

SYSTEM PARAMETER Page 3

- Model Name: Set the UPS model name.
- Serial Number: Set the serial number.
- Manufacturer: Set the UPS manufacturer.
- Charge Current:
 - One piece of charger: There are twelve options: 1A, 2A, 3A, 4A, 5A, 6A, 7A, 8A, 9A, 10A, 11A, 12A.
 - Two pieces of charger: There are twelve options: 2A, 4A, 6A, 8A, 10A, 12A, 14A, 16A, 18A, 20A, 22A, 24A
- BATT Number: The total number of installed battery. (It's required to restart the UPS after setting.) The setting range is 16 ~ 20. 16 is default setting.
- Charger VOL: The setting point of battery float voltage. 13.6V is default setting.

- UPS Type: There are two options, HV and LV. This change is only allowed for qualified technician.
NOTE: It's required to restart the UPS after setting.
- Power Set: Set the UPS power.
- Output Set: There are two options, 3-3 and 3-1. This change is only allowed for qualified technician.
NOTE: It's required to restart the UPS after setting.
- D Password: Enable or disable dynamic password.
- CustomerID: Used to produce dynamic password.

INSTALL

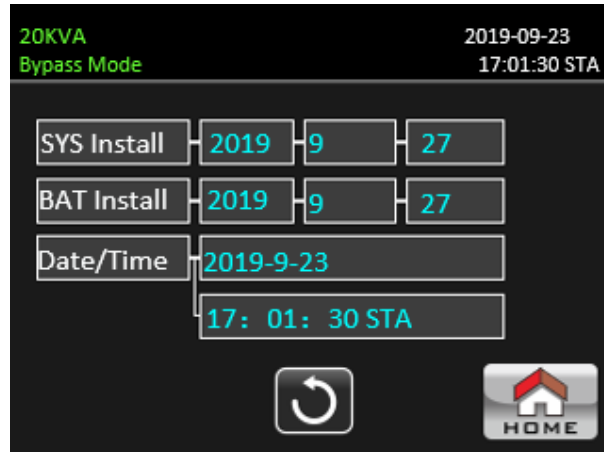



INSTALL Page

- System Install Date: Set the date of UPS installation.
- Battery Install Date: Set the date of Battery installation.
- Date/Time: Set the date and time. The format is YYYY-MM-DD HH:MM:SS. The calendar day will be automatically changed when the year, month and date are set.

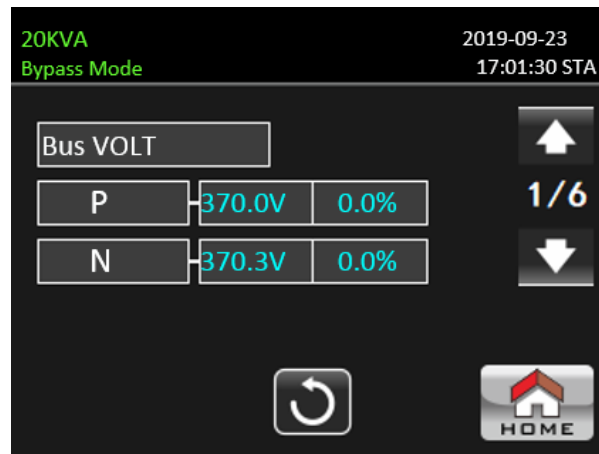
VOLTAGE CALIBRATE



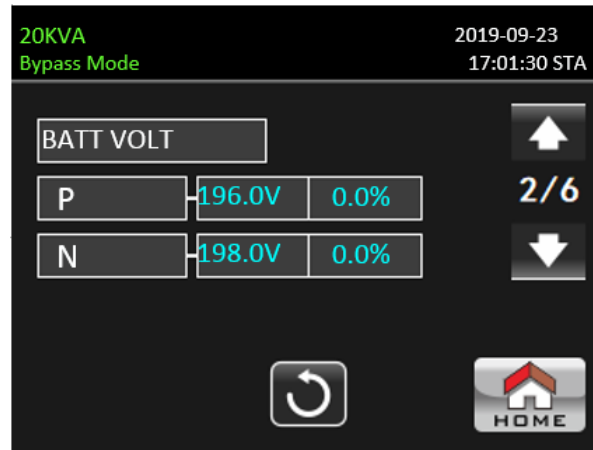

VOLTAGE CALIBRATE Page1

- Bus VOL: BUS voltage calibration. Click value columns and it will pop up . Then, each click is 0.1% no matter it's pressing up or down key . Press "up" key to increase 0.1% and press "down" key to decrease 0.1%. Press "OK" key to confirm the modification.



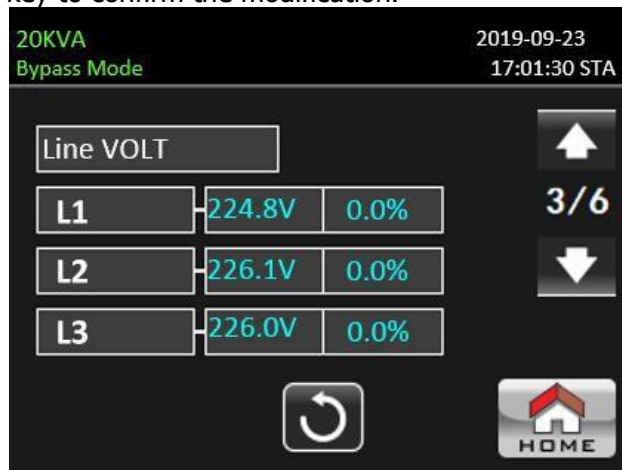

VOLTAGE CALIBRATE Page2

➤ BATT VOL: Battery voltage calibration. Click value columns and it will pop up . Then, each click is 0.1% no matter it's pressing up or down key . Press "up" key to increase 0.1% and press "down" key to decrease 0.1%. Press "OK" key to confirm the modification.



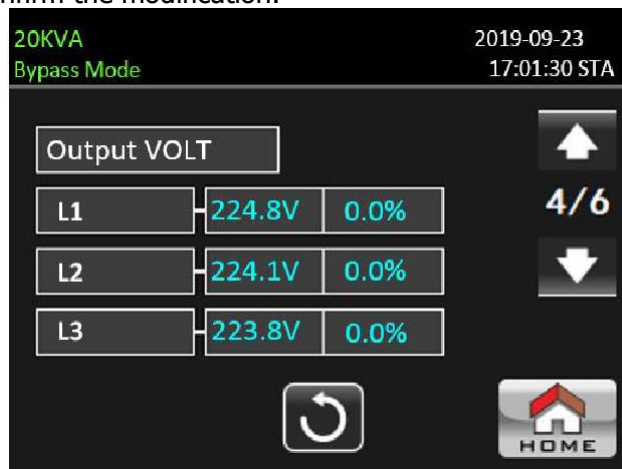

VOLTAGE CALIBRATE Page3

➤ Line VOL: Line voltage calibration. Click value columns and it will pop up . Then, each click is 0.1% no matter it's pressing up or down key . Press "up" key to increase 0.1% and press "down" key to decrease 0.1%. Press "OK" key to confirm the modification.





VOLTAGE CALIBRATE Page4

➤ Output VOL: Output voltage calibration. Click value columns and it will pop up . Then, each click is 0.1% no matter it's pressing up or down key . Press "up" key to increase 0.1% and press "down" key to

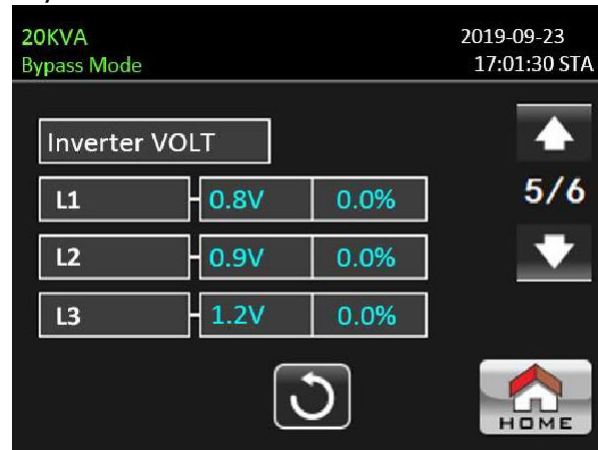
decrease 0.1%. Press "OK" key to confirm the modification.



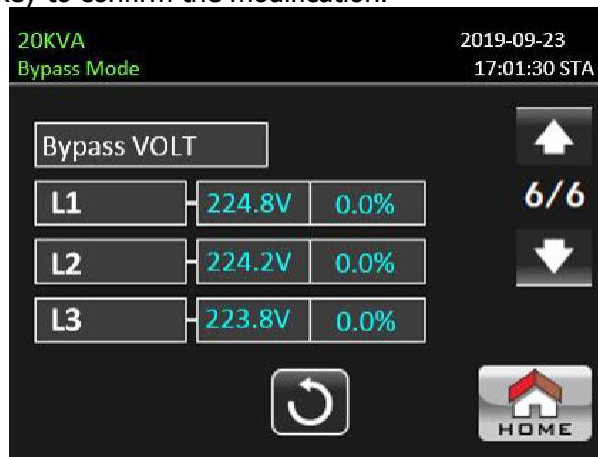

VOLTAGE CALIBRATE Page5

➤ Inverter VOL: Inverter voltage calibration. Click value columns and it will pop up . Then, each click is 0.1% no matter it's pressing up or down key . Press "up" key to increase 0.1% and press "down" key to decrease 0.1%. Press "OK" key to confirm the modification.



VOLTAGE CALIBRATE Page6

➤ Bypass VOL: Bypass voltage calibration. Click value columns and it will pop up . Then, each click is 0.1% no matter it's pressing up or down key . Press "up" key to increase 0.1% and press "down" key to decrease 0.1%. Press "OK" key to confirm the modification.

CURRENT CALIBRATE

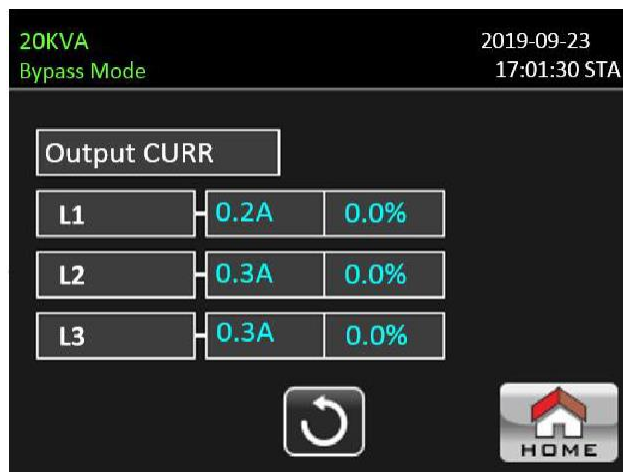

Current Calibrate Page

- Output CURR: Output current calibration. Click value columns and it will pop up. Then, each click is 0.1% no matter it's pressing up or down key . Press "up" key to increase 0.1% and press "down" key to decrease 0.1%. Press "OK" key to confirm the modification.

INITIAL

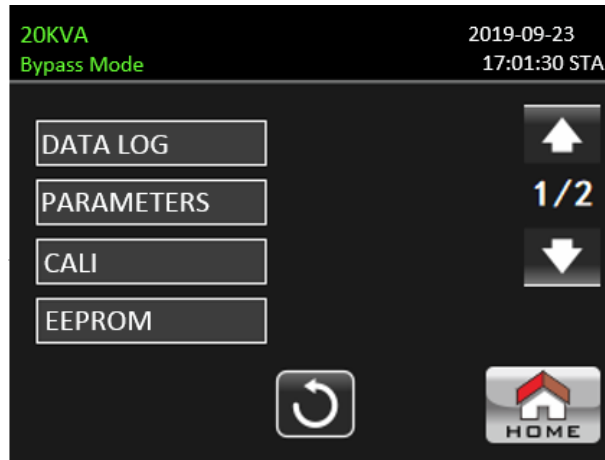

INITIAL menu Page1

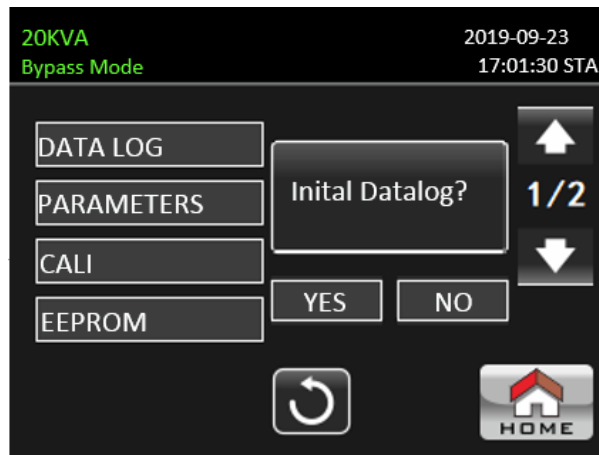

INITIAL → Datalog Page

- DATA LOG: After clicking "DATA LOG", it will pop up a message board as shown in above screen. Touch "YES" to clear the DATALOG page. Touch "No" to cancel this operation. Touch to return to INITIAL menu page.

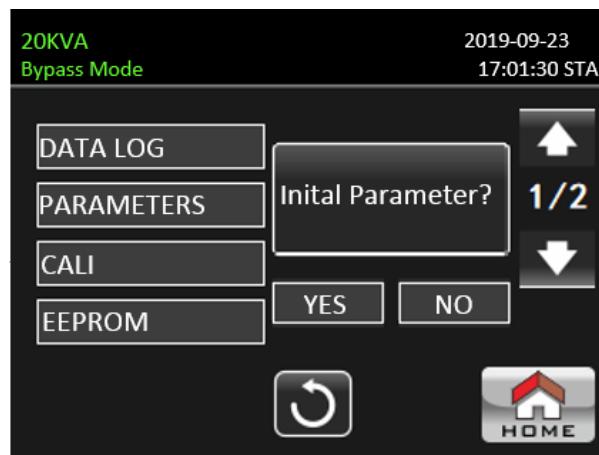

INITIAL →Parameter Page

- PARAMETERS: After clicking "PARAMETERS", it will pop up a message screen as shown in above screen. Touch "YES" to restore default value. Touch "No" to cancel this operation. Touch to return to INITIAL menu page.

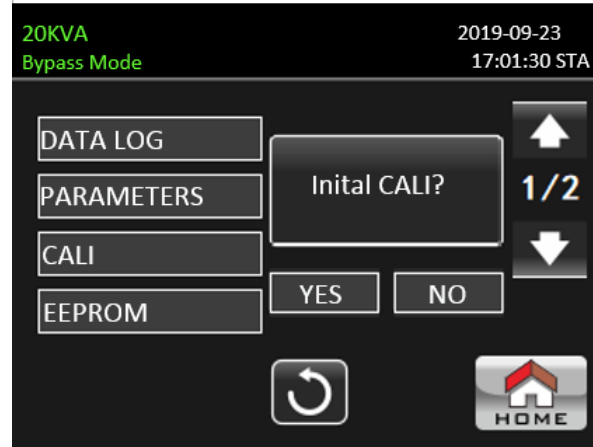

INITIAL → CALI Page

- CALIBRATE: After clicking "CALI", it will pop up a message board as shown in above screen. Touch "YES" to restore default calibration value. Touch "No" to cancel this operation. Touch "↺" to return to INITIAL menu page.

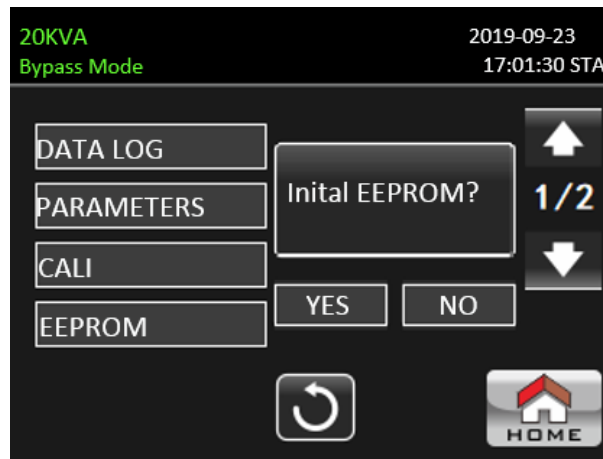

INITIAL → EEPROM Page

- EEPROM: After clicking "EEPROM", it will pop up a message board as shown in above screen. Touch "YES" to clear all setting value in EEPROM. Touch "No" to cancel this operation. Touch "↺" to return to INITIAL menu page.



INITIAL → TOUCH CALI Page

- TOUCH CALI: After pressing the confirmation window, it will pop up as shown in above screen. Touch screen to recalibrate. Then, the blue screen appears and please click on the place of the cross with your mouse.

ELECTRIC

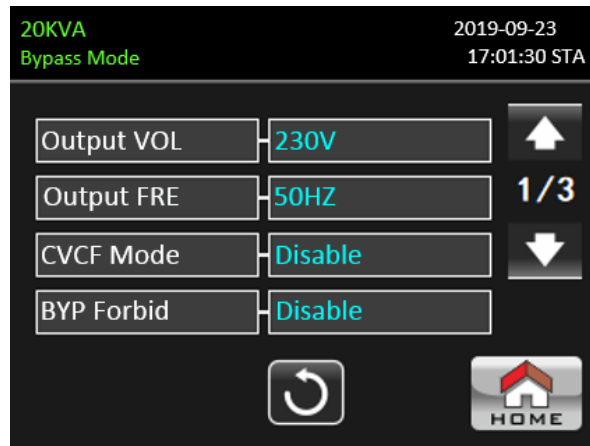

Electric Page 1

- Output VOL: Select the output rated voltage.
 - When UPS is HV system, there are four options, 208V, 220V, 230V and 240V.
 - When UPS is LV system, there are two options, 120V and 127V.
- Output FRE: Select output rated frequency.
 - **50Hz:** The output frequency is setting for 50Hz.
 - **60Hz:** The output frequency is setting for 60Hz.
- CVCF Mode (constant voltage and constant frequency function)
 - **Enable:** CVCF function is enabled. The output frequency will be fixed at 50Hz or 60Hz according to setting of "Output Freq.". The input frequency could be from 46Hz to 64Hz.
 - **Disable:** CVCF function is disabled. The output frequency will synchronize with the bypass frequency within 46~54 Hz for 50Hz system or within 54~64 Hz for 60Hz system. Disable is the default setting.
- Bypass Forbid:
 - **Enable:** Bypass Forbid is enabled. It's not allowed for running in Bypass mode under any situations.
 - **Disable:** Bypass Forbid is disabled. UPS will run in Bypass mode. It is the default setting.

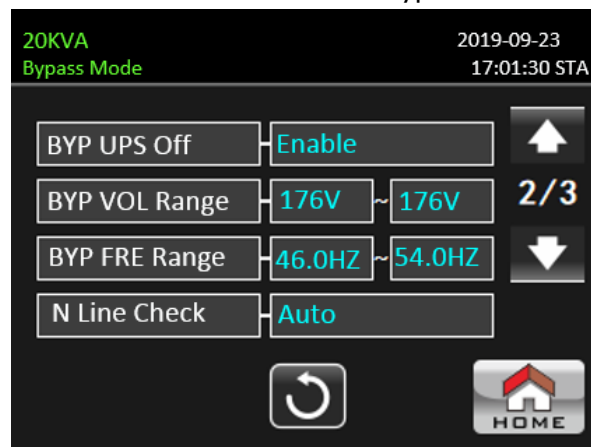

Electric Page 2

- Bypass at UPS off: Select the bypass status when manually turning off the UPS. This setting is only available when "Bypass forbid" is set to "Disable".
 - **Enable:** Bypass enabled. When selected, bypass mode is activated.
 - **Disable:** Bypass disabled. When selected, no output through bypass when manually turning off the UPS.
- Bypass Voltage Range: Set the bypass voltage range.

- **L:** Low voltage point for bypass. The setting range is 176V ~ 209V when the UPS is HV system. The setting range is 96V ~ 110V when the UPS is LV system.
 - **H:** High voltage point for bypass. The setting range is 231V ~ 264V when the UPS is HV system. The setting range is 139V ~ 146V when the UPS is LV system.
- Bypass FRE Range: Set the bypass frequency range.
- The acceptable bypass frequency range from 46Hz to 54Hz when UPS is 50Hz system and from 56Hz to 64Hz when UPS is 60Hz system.
- N Line Check: Check if neutral line is correctly connected or not.
- **Disable:** Disable the neutral loss detection function. The UPS will not detect the neutral loss or not.
 - **Auto:** The UPS will automatically detect the neutral is lost or not. If neutral loss is detected, an alarm will be generated. If the UPS is turned on, it will transfer to battery mode. When neutral is restored and detected, the alarm will be muted automatically and the UPS will go back to normal mode automatically.
 - **CHE:** The UPS will detect the neutral loss or not only when first commission. If neutral loss is detected, an alarm will be generated. If the UPS is turned on, it will transfer to battery mode. When neutral is restored, the alarm will NOT be muted automatically and the UPS will NOT go back to normal mode automatically. Please be sure to enter this selection and re-start the UPS again to mute alarm.

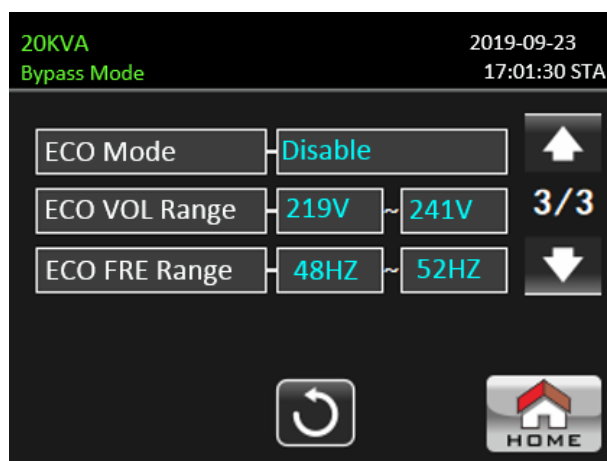

Electrical Setting Page 3

- ECO mode: Enable/Disable ECO mode. Default setting is "Disable".
- ECO Voltage Range: Set the ECO voltage range.
- **L:** Low voltage point for ECO mode. The setting range is from (Rated output voltage – 5V) to (Rated output voltage - 11V). "Rated output voltage – 5V" is default setting.
 - **H:** High voltage point for ECO mode. The setting range is from (Rated output voltage + 5V) to (Rated output voltage + 11V). "Rated output voltage + 5V" is default setting.
- ECO FRE Range: Set the ECO frequency range. The setting range is from 48Hz to 52Hz when the UPS is 50Hz system and from 58Hz to 62Hz when the UPS is 60Hz system.

BATTERY

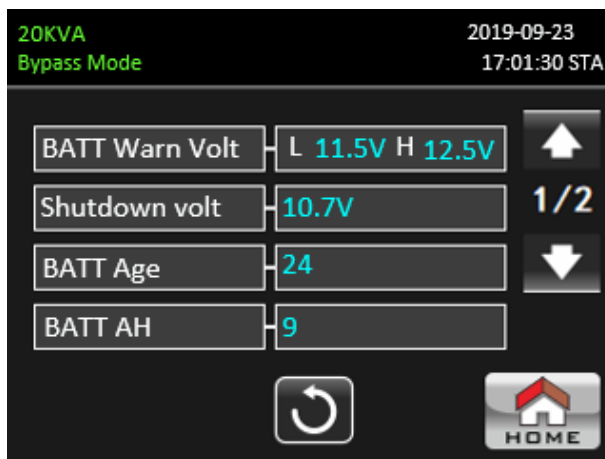

Battery setting page1

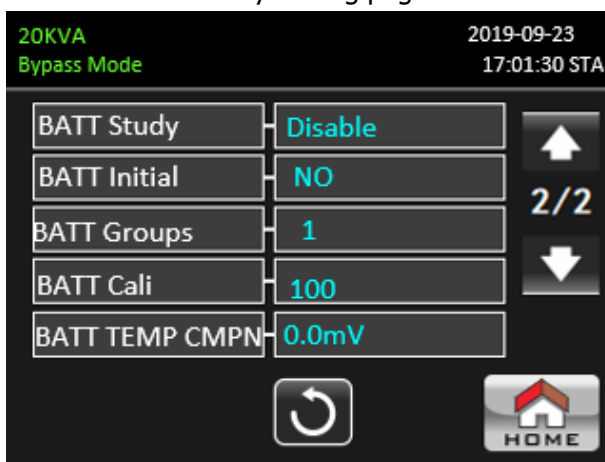

Battery setting page2

- Battery Warning Voltage:
 - **HIGH:** High battery warning voltage. The setting range is 14.0V ~ 15.0V. 14.4V is default setting.
 - **LOW:** Low battery warning voltage. The setting range is 10.1V ~ 14.0V. 11.4V is default setting. This parameter setting is related to "Shutdown Voltage" setting. The setting value should be higher than "Shutdown Voltage" setting.
- Shutdown Voltage: If battery voltage is lower than this point in battery mode, UPS will automatically shut down. The setting range is 10.5V ~ 12.0V. 10.7V is default setting (This setting is only available for long-run model)
- Battery age: if battery age is beyond the setting month, then the UPS will alarm for reminding. The factory default setting is 24 months.
- Battery AH: setting battery capacity.
- Battery Groups: setting battery groups.
- Battery Study:
 - **Enable:** The backup time prediction has a self-learning function to calibrate the battery virtual capacity according to a complete charging and discharging process.
 - **Disable:** The battery capacity will not be updated during the charging and discharging process.
- Battery Initial: The battery virtual capacity is initialized to 100%. Because the backup time has self-learning function, after the battery is used for a long time, after each full charge is completed, the virtual capacity of the battery will be continuously updated. After replacing the new battery, the virtual of the battery needs to be initialized at this time.
- Battery Cali: Calibration backup time.
- Battery TEMP CMPN(Compensation): According to the temperature compensate charging voltage.

OTHERS

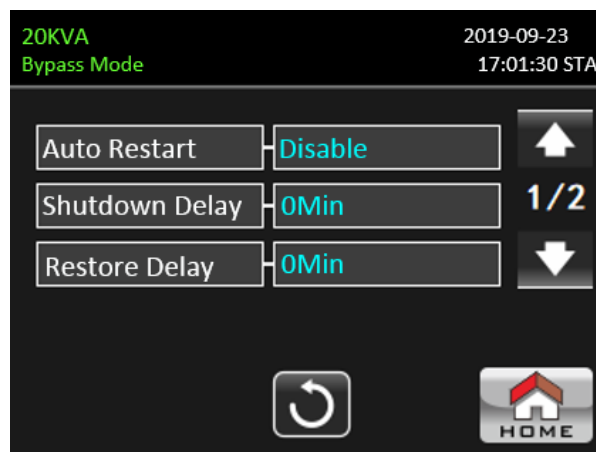

OTHERS setting page1

- Auto Restart:
 - **Enable:** After "Enable" is set, once UPS shutdown occurs due to low battery and then utility restores, the UPS will return to line mode.
 - **Disable:** After "Disable" is set, once UPS shutdown occurs and the utility restores, the UPS will not automatically turn on.
- Shutdown Delay Min: UPS will shut down in setting minutes. The countdown will start after confirming the pop-up screen.
- Restore Delay Min: UPS will automatically restart in setting minutes after the UPS shuts down.

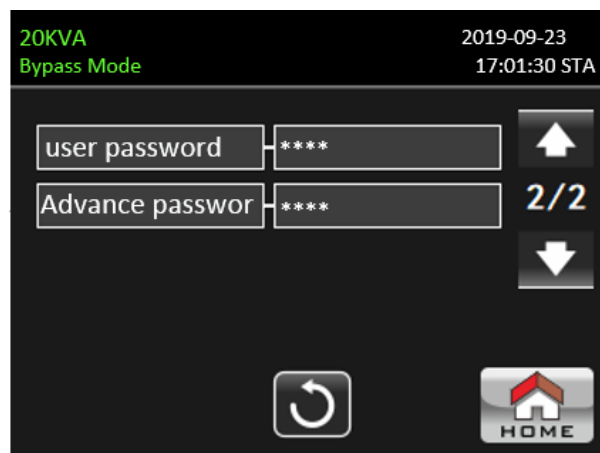

OTHERS setting page2

- User Password: Set up User new password to enter "ADVANCE➔ User" menu page.
- Advance Password: Set up User new password to enter "ADVANCE➔ Maintainer" menu page.

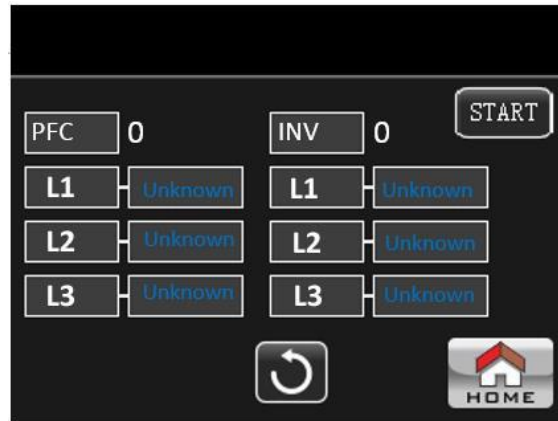

SELFTEST



This function is only effective when UPS type setting is "HV". Therefore, please disconnect all loads and utility first before executing this function. Then, please change UPS type to "HV". For the detailed operation, please check "System Parameter" menu under Advance → Maintainer directory.

After changing UPS type to "HV", you have to restart the UPS. After the UPS is restarted, please enter Advance screen and enter Maintainer password. It will show "SELFTEST" selection in the screen. In the screen, all tested items are shown "unknown". Simply click "START" button, the UPS will start self-test. If the UPS is normal, it will show "Normal" in all columns. Otherwise, "Unknown" will be displayed in the columns.

3-2-5. Information screen

Touch the icon  to enter information page. There are three sub-menus: BASIC, RATED and PARAMETER. Touch the icon  to return to main screen. Touch the icon  to go back to previous menu.

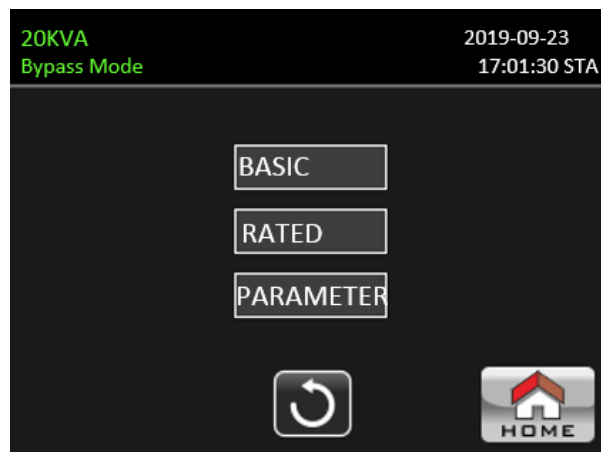

Basic Information Page 1

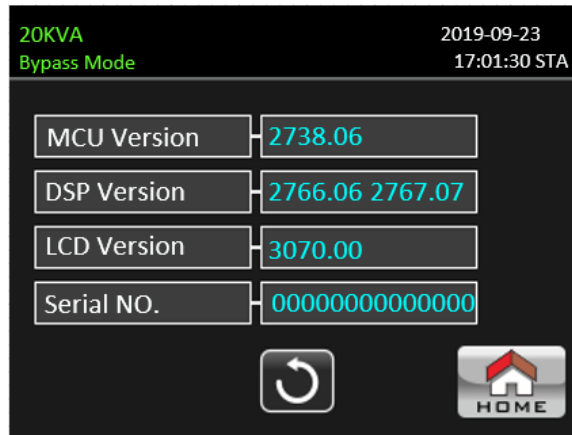

Basic Information Page 2

Basic Information

- MCU Version: MCU version.
- DSP Version: PDC INV version.
- LCD Version: LCD version.
- Serial NO.: The serial number of UPS.

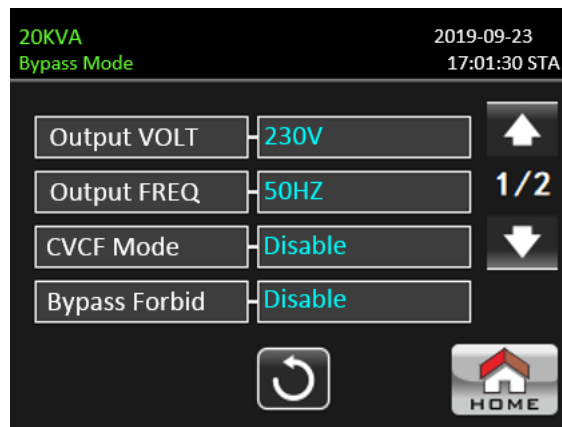

Rated Information Page1

Rated Information

- Output Voltage: It shows output rated voltage.
- Output Frequency: It shows output rated frequency.
- CVCF Mode: Enable/Disable CVCF mode.
- Bypass Forbid: Enable/disable bypass function.

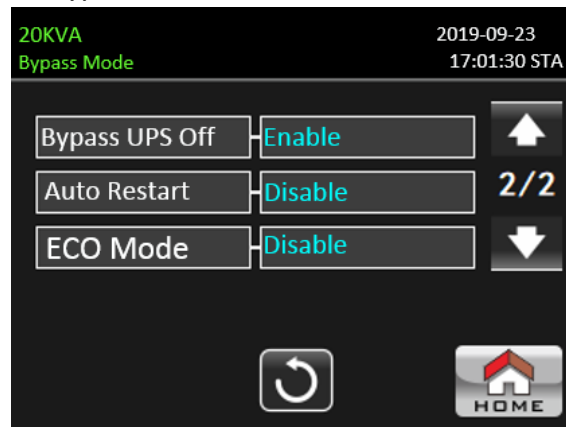

Rated Information Page2

- Bypass at UPS Off: Enable/disable auto bypass function when UPS is off.
- Auto Restart: Enable/disable auto-restart function.
- ECO Mode: Enable/disable ECO function.

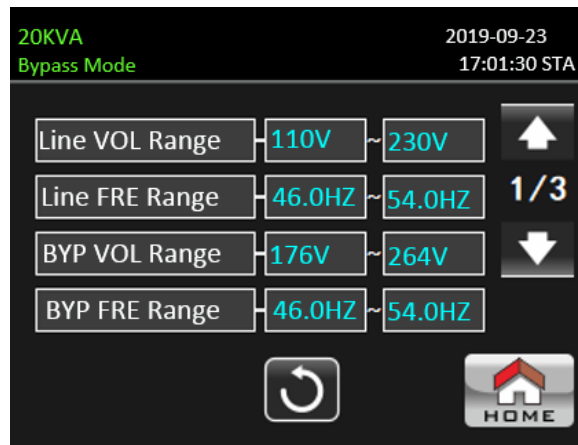

Parameter Information Page 1

Parameter Information

- Line Voltage Range: The acceptable line input voltage range.
- Line FRE Range: The acceptable line input frequency range.
- Bypass Voltage Range: The acceptable input voltage range for bypass mode.
- Bypass FRE Range: The acceptable input frequency range for bypass mode.



Parameters Information Page 2

- ECO Voltage Range: The acceptable input voltage range for ECO mode.
- ECO FRE Range: The acceptable input frequency range for ECO mode.
- BATT Work Time: The maximum discharge time in battery mode.
- BATT Warning Voltage:
 - **LOW**: Low battery warning voltage.
 - **HIGH**: High battery warning voltage.

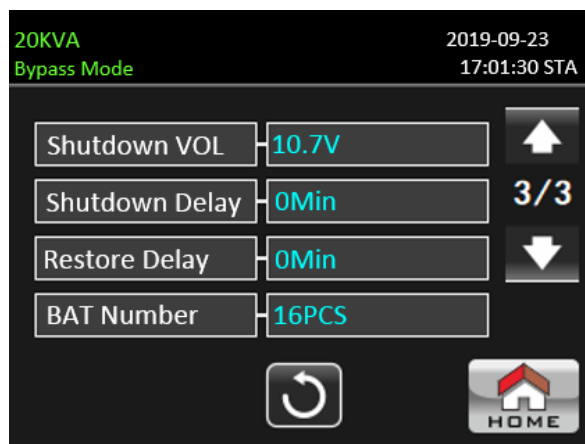





Parameters Information Page 3

- Shutdown Voltage: If battery voltage is lower this point, UPS will automatically shut down.
- Shutdown Delay: set time to delay ups shutdown.
- Restore Delay: UPS will automatically restart in setting minutes after the UPS shuts down.
- Battery Numbers: It shows battery number.

3-2-6. Data Log screen



Touch the icon  to enter date log page. Data log is used to record the warning and fault information of the UPS. The record contains date & time, type and description. Touch the icon  or  to page up or down if there are more than one page in the date log. Touch the icon  to return to main screen. Press the icon  to go back to main menu. Please refer to Section 3-6 and 3-7 for warning and fault code list.

20KVA		2019-09-23	
Bypass Mode		17:01:30 STA	
Time	Type	Describe	
19/09/23 17:00:20	Mode	PowerOn Mode	

Datalog Page

3-3. Audible Alarm

Description	Buzzer status	Muted
UPS status		
Bypass mode	Beeping once every 2 minutes	Yes
Battery mode	Beeping once every 4 seconds	
Fault mode	Beeping continuously	
Warning		
Overload	Beeping twice every second	No
Others	Beeping once every second	
Fault		
All	Beeping continuously	Yes

3-4. Single UPS Operation

1. Turn on the UPS with utility power (in AC mode)

- 1) After power mains is connected correctly, set the breaker of the battery pack to "ON" position (this step only necessary for long-run model). Then set the line input breaker to "ON" position. At the same time the fan will start running and the UPS will start initialization. In just a few seconds, the UPS will supply power to the loads via the Bypass mode.

NOTE: When UPS is in Bypass mode, the output voltage will be directed from mains after you switch on the input breaker. In Bypass mode, the load is not protected by the UPS. To protect your precious devices, you should turn on the UPS. Refer to next step.

- 2) Touch "CONTROL" and select "On UPS?" icon. It will show "On UPS?" in screen and select "Yes". Refer to On/Off UPS screen.
- 3) In just a few seconds, the UPS will enter into AC mode. If the mains is abnormal, the UPS will operate in Battery mode without interruption.

NOTE: When the UPS runs out battery, it will shut down automatically in Battery mode. When the mains is normalized, the UPS will auto restart in AC mode.

2. Turn on the UPS without utility power supply (in Battery mode)

- 1) Make sure that the two strings of batteries are connected correctly in order of "+,GND,-" terminals and the breaker of the battery pack is at "ON" position.
- 2) Press the **POWER** button to set up the power supply for the UPS. UPS will enter to power on mode. After initialization, UPS will enter to "No Output mode".
- 3) In just a few seconds, the UPS will be turned on and enter into Battery mode.

3. Connect devices to UPS

After the UPS is turned on, you can connect devices to the UPS.

- 1) Turn on the UPS first and then switch on the devices one by one. The LCD panel will display total load level.
- 2) If it is necessary to connect the inductive loads such as a printer, the in-rush current of the load should be calculated carefully to see if it meets the overload capability of the UPS. Any load more than 150% over designed capacity the runtime will be less than 60ms
- 3) If the UPS is overload, the buzzer will beep twice every second.
- 4) When the UPS is overload, please remove some loads immediately. It is recommended to have the total loads connected to the UPS less than 80% of its nominal power capacity to prevent overload for system safety.
- 5) If the overload time is over acceptable time listed in spec in AC mode, the UPS will automatically transfer to Bypass mode. After the overloading was resolved, it will return to AC mode. If the overload time is over acceptable time listed in spec in Battery mode, the UPS will enter fault status. At this time, if bypass is enabled, the UPS will power to the load via bypass. If bypass function is disabled or the input power is not within bypass acceptable range, it will cut off output entirely.

4. Charge the batteries

- 1) After the UPS is connected to the mains and turned on in AC mode, the charger will charge the batteries automatically except in battery mode, during battery self-test, overload or when battery voltage is high.
- 2) It's recommended to charge batteries for at least 10 hours before operation. Otherwise, the backup time may be shorter than expected.

5. Battery mode operation

- 1) When the UPS is in Battery mode, the buzzer will sound according to different battery capacity. If the battery capacity is more than 25%, the buzzer will beep once every 4 seconds. If the battery voltage drops to the alarm level, the buzzer will beep once every sec to remind users that the battery is at low level and the UPS will shut down imminently. Users could switch off some non-critical loads to disable the shutdown alarm and prolong the backup time. If there is no more load to be switched off, you have to prepare shutdown procedure to preserve working data or devices. Otherwise, there is a risk of data loss or load failure.
- 2) In Battery mode, users can touch "SETTING" → "GENERAL" → Audio Mute to enable "Mode Mute" to disable the buzzer.
- 3) The backup time of the long-run model depends on the external battery capacity.
- 4) The backup time may vary from different operating temperature and load type.
- 5) When setting backup time for 16.5 hours (default value from LCD menu), after discharging 16.5 hours, UPS will shut down automatically to protect the battery. This battery discharge protection can be enabled or disabled through LCD menu.

6. Test the batteries

- 1) If you need to check the battery status when the UPS is running in AC mode/CVCF mode, you could touch "CONTROL" and select "Battery Test". Refer to "Battery Test" screen.
- 2) Users also can set battery self-test through monitoring software.

7. Turn off the UPS with utility power supply in AC mode

- 1) Touch "CONTROL" and select "Turn off UPS" icon to turn off the UPS. Refer to "On/Off UPS" screen.
NOTE 1: If the UPS has been set to bypass output, it will bypass voltage from the mains to output terminal even though you have turned off the UPS (inverter).
NOTE 2: After turning off the UPS, please be aware that the UPS is working in Bypass mode, there will be risk of power loss for connected devices.
- 2) In Bypass mode, output voltage of the UPS is still present. In order to cut off the output, switch off the line input breaker. The LCD display will turn off and UPS is now completely off.

8. Turn off the UPS without utility power supply in Battery mode

- 1) Touch "CONTROL" and select "Off UPS" icon to turn off the UPS. Refer to "On/Off UPS" screen.
- 2) Then UPS will cut off power to output terminals.

9. Mute the buzzer

- 1) Touch "SETTING" and select "GENERAL" item. There are two events available to mute. Refer to "SETTING" screen.
- 2) Some warning alarms can't be muted unless the error is fixed. Please refer to section 3-3 for details.

10. Operation in warning status

- 1) When LCD screen shows "Fault Mode" and the buzzer beeps once every second, it indicates that there are problems for UPS operation. Users can read the warning message(s) from "DATA LOG" menu. Please refer to the Chapter 4 for details.
- 2) Some warning alarms can't be muted unless the error is fixed. Please refer to section 3-3 for details.

11. Operation in Fault mode

- 1) When the buzzer beeps continuously, it means that there is a fatal error with the UPS. Users can get the fault code from "DATA LOG" menu. Please refer to the Chapter 4 for details.
- 2) Please check the loads, wiring, ventilation, mains, battery and so on after the fault occurs. Don't try to turn on the UPS again before solving the issues. If the problems persist, contact the distributor or service personnel immediately.
- 3) In case of an emergency, shut off connections from mains, external battery, and output immediately to avoid possible damage to the UPS or equipment.

12. Operation in maintenance bypass mode

This operation should only be performed by maintenance personnel or qualified technicians.

When the UPS needs to repair or service and the load could not be shut off, the UPS needs to be put into maintenance mode.

- 1) First, switch off the UPS.
- 2) Then, remove the cover of maintenance bypass switch on the panel.
- 3) Turn the maintenance switch to "BPS" position.

13. 33 model set to 31 model

A. First method

This operation should only be performed by maintenance personnel or qualified technicians.

- 1) Open the communication software



The following interface will appear.

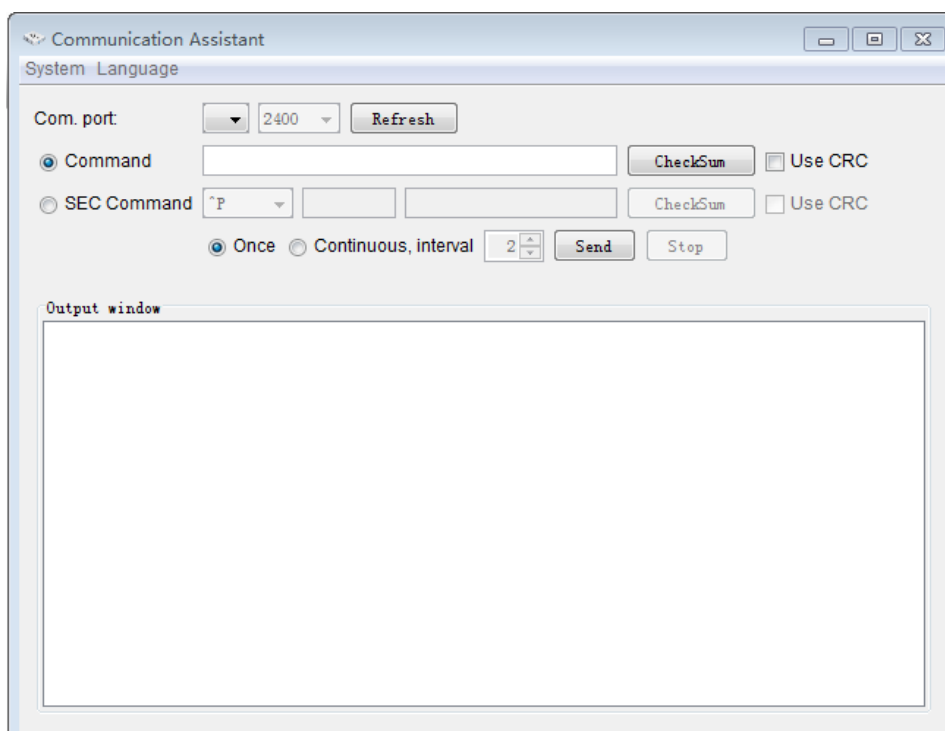

- 2) When setting up the battery parameter, please confirm that the UPS state is in bypass mode or standby mode.
- 3) Click "Refresh", "USB..." and "2400" will appear at the appropriate location.

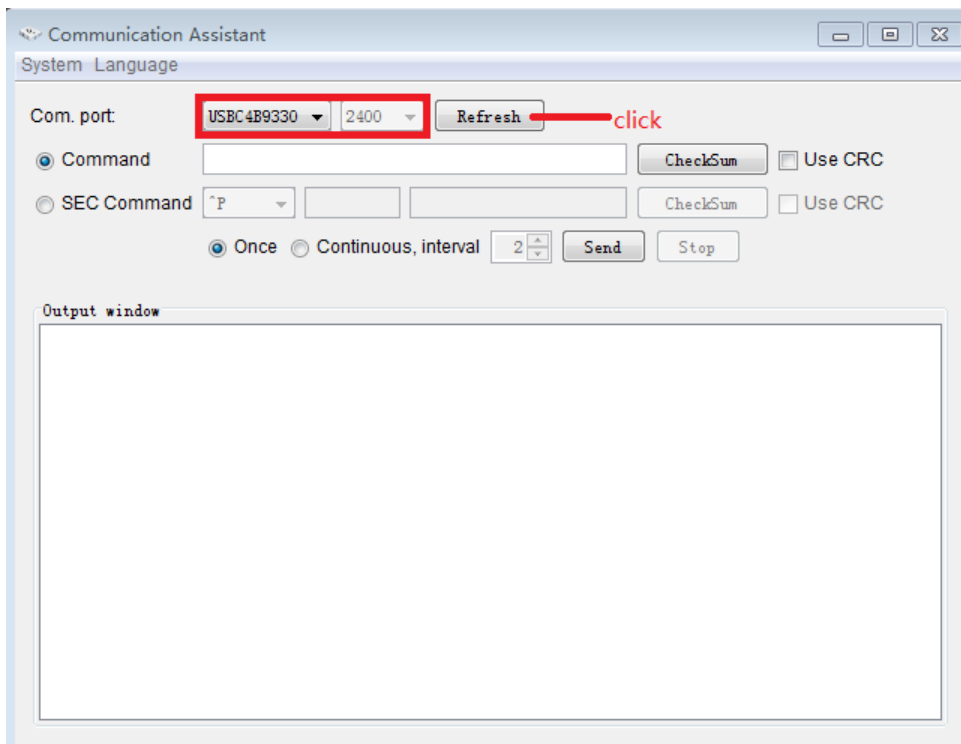

- 4) Enter the command "`^S006SOP31`" to set the UPS to 31 model. UPS will return "`^D006ACK`" when it accepts. If you want to set the UPS to 33 model, the command is "`^S006SOP33`".

Note: This parameter setting is not effected immediatly. The setting will be saved only when UPS shut down normally with battery connected.

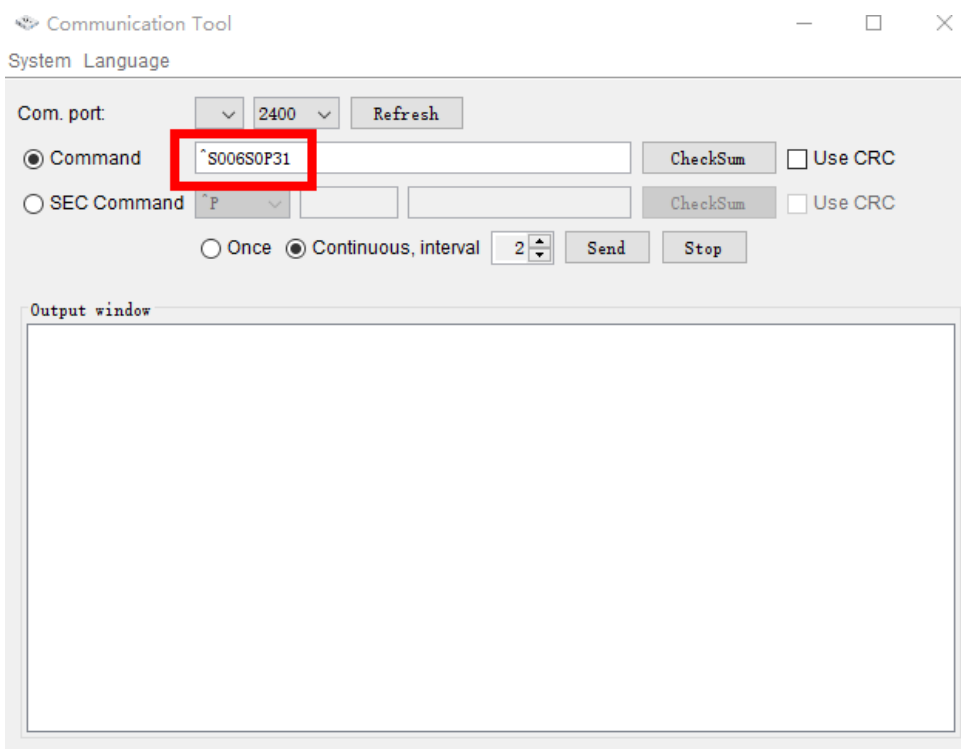

- 5) After the UPS shuts down normally, the output terminals need to be shorted.

31 Schematic diagram for the connection of short circuit sheet copper

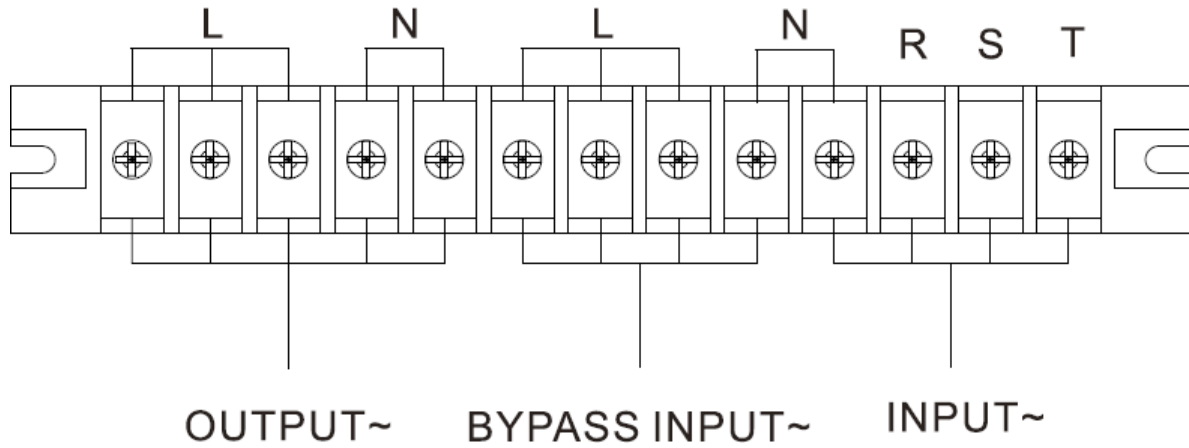

33 Schematic diagram for the connection of short circuit sheet copper

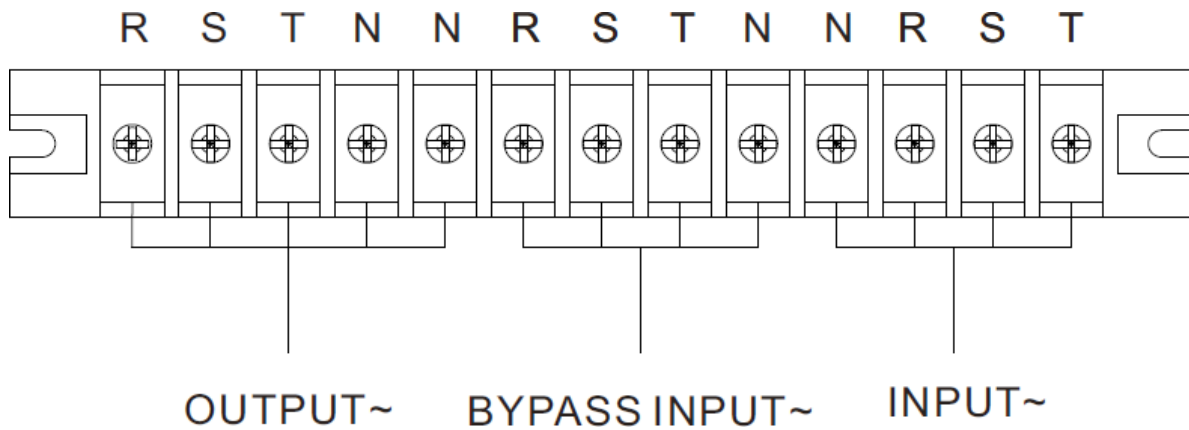

B. Second method

1) Press "SETTING" in bypass mode or standby mode.

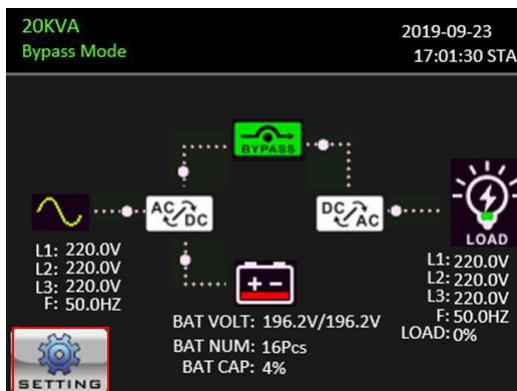

2) Enter password

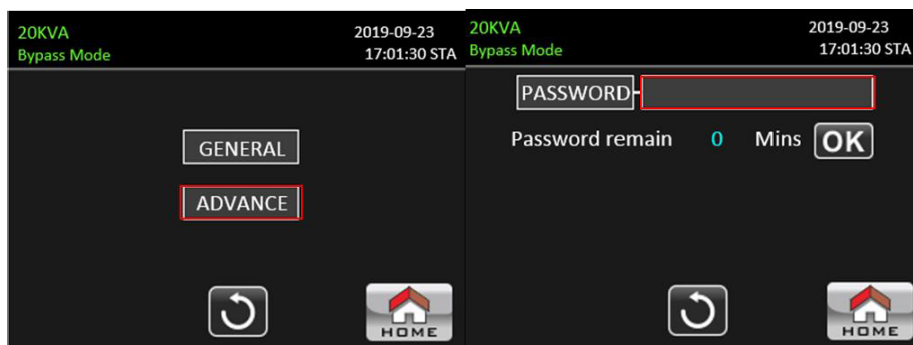

- 3) Press "SYS PARSMETER" then go to page 2. Select "Output Settings" and change "3-3" to "3-1".

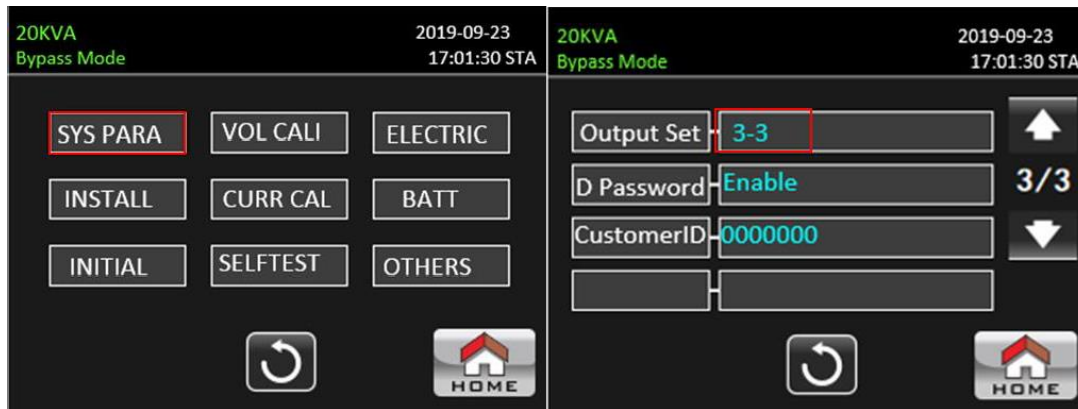

NOTE: The parameter settings will be saved only when UPS shuts down normally with battery connected.

3-5. Parallel Operation

1. Parallel system initial startup

Please make sure that all of the running UPSs are parallel models and have the same configuration.

- 1) Turn on each UPS in AC mode respectively (Refer to section 3-4(1)). Then, measure the inverter output voltage of each phase for each UPS with a multi-meter. Calibrate the inverter output voltage by configuring inverter voltage adjustment (Refer to SETTING → ADVANCE → SYS PARAMETERS → VOL CALI screen) in LCD menu until the inverter output voltage difference of each UPS is within 1V or less.
- 2) Turn off each UPS (Refer to section 3-4(7.)). Then, follow the wiring procedure in section 2-4.
- 3) Remove the cover of parallel share current cable port on the UPS, connect each UPS one by one with the parallel cable and share current cable, and then replace the cover.
- 4) **Turn on the parallel system in AC mode:**
 - a) Turn on the line input breaker of each UPS. If using dual-input unit, please also turn on the external bypass input breaker. After all UPSs enter into bypass mode, measure the output voltage between two UPSs for the same phase to make sure the phase sequence is correct. If these two voltage differences are near to zero, that means all connections are met. Otherwise, please check if the wirings are connected correctly.
 - b) Turn on the output breaker of each UPS.
 - c) Turn on each UPS in turns. After a while, the UPSs should enter into AC mode synchronously and then, the parallel system is now complete.
- 5) **Turn on the parallel system in Battery mode:**
 - a) Turn on the battery breaker and external output breaker of each UPS.
 - b) Turn on any UPS. A few seconds later, the UPS will enter into battery mode.
 - c) Turn on the next UPS in sequence until all the UPSs enter into Battery mode and add to the parallel system. Now the parallel system is now complete.

If you would like to have more information regarding the parallel operation, please contact your supplier or service center for detail parallel operation instruction.

2. Add new units into the parallel system

- 1) You can not add new unit into the parallel system when whole system is running. You must cut off the load and shutdown the system.
- 2) Make sure all of the UPS are the parallel models, and follow the wiring reference in section 2-4.
- 3) Install the new parallel system as per section 3-5.

3. Remove units from the parallel system

There are two methods to remove units from the parallel system:

First method:

- 1) Touch "CONTROL" → "Off UPS" and select "Yes" to turn off the UPS. Then, the UPS will enter into Bypass mode or No Output mode without output.
- 2) Turn off the output breaker of this unit, and then turn off the input breaker of this unit.
- 3) Turn off the battery breaker and remove the parallel and share current cables. And then remove the unit from the parallel system.

Second method:

- 1) If the bypass is abnormal, you can not remove the UPS without interruption. You must cut off the load and shut down the system.
- 2) Make sure the bypass setting is enabled in each UPS and then turn off the system. All UPSs will transfer to Bypass mode. Remove all the maintenance bypass covers and set the maintenance switches from "UPS" to "BPS" position. Turn off all the input breakers and battery breakers in parallel system.
- 3) Turn off the output breaker and remove the parallel cable and share current cable of the UPS which you want to remove. Now, you can remove the UPS from parallel system.
- 4) Turn on the input breaker of the remaining UPS and the system will transfer to Bypass mode. Set the maintenance switches from "BPS" to "UPS" position and put the maintenance bypass covers back on.
- 5) Turn on the remaining UPS according to the previous section.



Warning: (Only for the parallel system)

- Before turning on the parallel system to activate inverter, make sure that all unit's maintenance switch at the same position.
- When parallel system is turned on, please do not operate the maintenance switch of any unit.
- The parallel system DOES NOT support ECO mode. Therefore, please DO NOT "enable" ECO mode in any unit.

3-6. Fault Code

Fault code	Fault event	Icon	Fault code	Fault event	Icon
01	Bus start failure	None	41	Over temperature	None
02	Bus over	None	42	DSP communication failure	None
03	Bus under	None	43	Overload	None
04	Bus unbalance	None	46	Incorrect UPS setting	None
06	Converter over current	None	47	MCU communication failure	None
11	Inverter soft start failure	None	48	Two DSP firmware versions are incompatible in parallel system.	None
12	High inverter voltage	None	60	Bypass phase short circuited	None
13	Low inverter voltage	None	61	Bypass SCR short circuited	None
14	Inverter L1 output(line to neutral) short circuited	None	62	Bypass SCR open circuited	None
15	Inverter L2 output(line to neutral) short circuited	None	63	Voltage waveform abnormal in R phase	None
16	Inverter L3 output(line to neutral) short circuited	None	64	Voltage waveform abnormal in S phase	None
17	Inverter L1-L2 output (line to line) short circuited	None	65	Voltage waveform abnormal in T phase	None
18	Inverter L2-L3 output (line to line) short circuited	None	66	Inverter current sample abnormal	None
19	Inverter L3-L1 output (line to line) short circuited	None	67	Bypass O/P short circuited	None
1A	Inverter L1 negative power fault	None	68	Bypass O/P line to line short circuited	None
1B	Inverter L2 negative power fault	None	69	Inverter SCR short circuited	None
1C	Inverter L3 negative power fault	None	6C	BUS voltage drops too fast	None
21	Battery SCR short circuited	None	6D	Current sampling error value	None
23	Inverter relay open circuited	None	6E	SPS power error	None
24	Inverter relay short circuited	None	6F	Battery polarity reverse	None
25	Line wiring fault	None	71	PFC IGBT over-current in L1 phase	None
31	Parallel communication failure	None	72	PFC IGBT over-current in L2 phase	None
32	The host signal failure	None	73	PFC IGBT over-current in L3 phase	None
33	Synchronous signal failure	None	74	INV IGBT over-current in L1 phase	None
34	Synchronous trigger signal failure	None	75	INV IGBT over-current in L2 phase	None
35	Parallel communication loss	None	76	INV IGBT over-current in L3 phase	None
36	Parallel output current unbalance	None	78	LCD & MCU communication failure	None

3-7.Warning Code

Warning code	Warning event	Warning code	Warning event
01	Battery unconnected	21	Line situations are different in parallel system
02	IP Neutral loss	22	Bypass situations are different in parallel system
04	IP phase abnormal	33	Locked in bypass after overload 3 times in 30 minutes
05	Bypass phase abnormal	34	Converter current unbalanced
07	Over charge	3A	Cover of maintain switch is open
08	Low battery	3C	Utility extremely unbalanced
09	Overload	3D	Bypass is unstable
0A	Fan failure	3E	Battery voltage too high
0B	EPO enable	3F	Battery voltage unbalanced
0D	Over temperature	40	Charger short circuited
0E	Charger failure	41	Bypass Loss
42	ISO Over Temperature	43	Bus Soft Error

4. Troubleshooting

If the UPS system does not operate correctly, please solve the problem by using the table below.

Symptom	Possible cause	Remedy
No indication and alarm in the front display panel even though the mains is normal.	The AC input power is not connected well.	Check if input cable firmly connected to the mains.
The warning code 0B.	EPO function is activated. At this time, the EPO switch is in "OFF" status or the jumper is open.	Set the circuit in closed position to disable the EPO function.
The warning code 01.	The external or internal battery is incorrectly connected.	Check if all batteries are connected well.
The warning code 09.	UPS is overload.	Remove excess loads from UPS output.
	UPS is overloaded. Devices connected to the UPS are fed directly by the electrical network via the Bypass.	Remove excess loads from UPS output.
	After repetitive overloads, the UPS is locked in the Bypass mode. Connected devices are fed directly by the mains.	Remove excess loads from UPS output first. Then shut down the UPS and restart it.
Fault code is shown as 43.	UPS is overload too long and becomes fault. Then UPS shut down automatically.	Remove excess loads from UPS output and restart it.
Fault code is shown as 14, 15, 16, 17, 18 or 19,	The UPS shut down automatically because short circuit occurs on the UPS output.	Check output wiring and if connected devices are in short circuit status.
Other fault codes are shown on LCD display and alarm beeps continuously.	A UPS internal fault has occurred.	Contact your dealer
Battery backup time is shorter than nominal value.	Batteries are not fully charged.	Charge the batteries for at least 7 hours and then check capacity. If the problem still persists, consult your dealer.
	Batteries defect	Contact your dealer to replace the battery.
The warning code 0A.	Fan is locked or not working. Or the UPS temperature is too high.	Check fans and notify dealer.
The warning code 02.	The input neutral wire is disconnected.	Check and correct the input neutral connection. If the connection is ok and the warning is still displaying, please enter LCD setting menu ADVANCE → User → Electric. Then, select "CHE" and restart the UPS.

5. Storage and Maintenance

5-1. Storage

Before storing, charge the UPS at least 7 hours. Store the UPS covered and upright in a cool, dry location. During storage, recharge the battery in accordance with the following table:

Storage Temperature	Recharge Frequency	Charging Duration
-25°C - 40°C	Every 3 months	1-2 hours
40°C - 45°C	Every 2 months	1-2 hours

5-2. Maintenance



The UPS system operates with hazardous voltages. Repairs may be carried out only by qualified maintenance personnel.



Even after the unit is disconnected from the mains, components inside the UPS system are still connected to the battery packs which are potentially dangerous.



Before carrying out any kind of service and/or maintenance, disconnect the batteries and verify that no current is present and no hazardous voltage exists in the terminals of high capability capacitor such as BUS-capacitors.



Only persons are adequately familiar with batteries and with the required precautionary measures may replace batteries and supervise operations. Unauthorized persons must be kept well away from the batteries.



Verify that no voltage between the battery terminals and the ground is present before maintenance or repair. In this product, the battery circuit is not isolated from the input voltage. Hazardous voltages may occur between the battery terminals and the grounding/earthing.



Batteries may cause electric shock and have a high short-circuit current. Please remove all wristwatches, rings and other conductive objects before maintenance or repair, and only use tools with insulated grips and handles for maintaining or repairing.



When replace the batteries, install the same number and same type of batteries.



Do not attempt to dispose of batteries by burning them. This could cause battery explosion. The batteries must be deposited according to local environmental regulations.



Do not open or destroy batteries. Escaping electrolyte can cause injury to the skin and eyes. It may be toxic.



Please replace the fuse only with the same type and amperage in order to avoid fire hazards.



Do not disassemble the UPS system.

6. Specifications

400V

MODEL		10KL	15KL	20KL	30KL
CAPACITY*		10KVA/10KW	15KVA/15KW	20KVA/20KW	30KVA/30KW
INPUT					
Voltage Range	Low Line Loss	110 VAC(Ph-N) ± 3 % at 50% Load; 176 VAC(Ph-N) ± 3 % at 100% Load			
	Low Line Comeback	Low Line Loss Voltage + 10V			
	High Line Loss	300 VAC(L-N) ± 3 % at 50% Load; 276 VAC(L-N) ± 3 % at 100% Load			
	High Line Comeback	High Line Loss Voltage - 10V			
Frequency Range		46Hz ~ 54 Hz @ 50Hz system 56Hz ~ 64 Hz @ 60Hz system			
Phase		3 Phase with Neutral			
Power Factor		≥ 0.99 at 100% Load			
OUTPUT					
Output voltage		3 x 360*/380/400/415 VAC (3Ph+N) or 208*/220/230/240 VAC (Ph-N)			
AC Voltage Regulation		± 1%			
Frequency Range (Synchronized Range)		46Hz ~ 54 Hz @ 50Hz system; 56Hz ~ 64 Hz @ 60Hz system			
Frequency Range (Batt. Mode)		50 Hz ± 0.1 Hz or 60Hz ± 0.1 Hz			
Overload	AC mode	100%~110%: 60min; 110%~125%: 10min; 125%~150%:1min;>150% : 400ms			
	Battery mode	100%~110%: 60min; 110%~125%: 10min; 125%~150%:1min;>150% : 400ms			
Current Crest Ratio		3:1 max			
Harmonic Distortion		≅ 2 % @ 100% Linear Load; ≅ 5 % @ 100% Non-linear Load			
Transfer Time	Line←→Battery	0 ms			
	Inverter←→Bypass	0 ms (When phase lock fails, <4ms interruption occurs from inverter to bypass)			
	Inverter←→ECO	<10 ms			
EFFICIENCY					
AC mode		95.5%			
Battery Mode		94.5%			
BATTERY					
Type		Depending on applications			
Numbers		20	32 ~ 40 (adjustable)		
Charging Current(max.)		1.0~12.0A ±10% (Adjustable)			
Charging Voltage		+/-136.5 VDC ± 1%	+/- 13.65 VDC * N ± 1% (N = 16~20)		
PHYSICAL					
Dimension, D X W X H mm		680X438X133(3U)			
Net Weight (kgs)		26	28	28	29
ENVIRONMENT					
Operation Temperature		0 ~ 40°C (the battery life will down when > 25°C)			
Operation Humidity		<95 % and non-condensing			
Operation Altitude**		<1000m**			
Acoustic Noise Level		Less than 62dB @ 1 Meter	Less than 65dB @ 1 Meter	Less than 65dB @ 1 Meter	Less than 65dB @ 1 Meter
MANAGEMENT					
Smart RS-232 or USB		Supports Windows® 2000/2003/XP/Vista/2008/7/8/10, Linux, Unix, and MAC			
Optional SNMP		Power management from SNMP manager and web browser			

* Derate capacity to to 90% when the output voltage is adjusted to 208VAC.

**If the UPS is installed or used in a place where the altitude is above than 1000m, the output power must be derated 1% per 100m.

***Product specifications are subject to change without further notice.

