

Nominal Voltage		12 V
Capacity (25°C)	10HR(10.8V)	33 Ah
	5HR(10.5V)	28.9Ah
	1HR(9.60V)	20.5Ah
Dimension	Length	195 ± 2mm (7.68inch)
	Width	130 ± 1mm (5.12inch)
	Height	155 ± 2mm (6.10inch)
	Total Height	T7: 180 ± 2mm (7.09inch) T9: 166 ± 2mm (6.54inch)
Approx. Weight		9.2kg (20.3lbs) ± 4%
Terminal type		T7/T9
Internal resistance (Fully charged, 25°C)		Approx. 10m Ω
Capacity affected by temperature (10HR)	40°C	102%
	25°C	100%
	0°C	85%
	-15°C	65%
Self-discharge (25°C)	3 month	Remaining Capacity: 91%
	6 month	Remaining Capacity: 82%
	12 month	Remaining Capacity: 65%
Nominal operating temperature		25°C ± 3°C (77°F ± 5°F)
Operating temperature range	Discharge	-15°C ~ 50°C (5°F ~ 122°F)
	Charge	-10°C ~ 50°C (14°F ~ 122°F)
	Storage	-20°C ~ 50°C (-4°F ~ 122°F)
Float charging voltage(25°C)	13.50 to 13.80V Temperature compensation: -18mV/°C	
Cyclic charging voltage(25°C)	14.50 to 14.90V Temperature compensation: -30mV/°C	
Maximum charging current	9.9A	
Terminal material	T7: Lead, T9: Copper	
Maximum discharge current	330A(5 sec.)	
Designed floating life(20°C)	12 years	

Dimensions

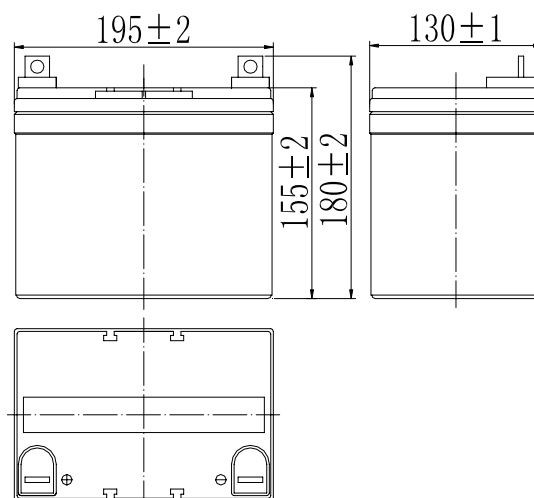

Terminal

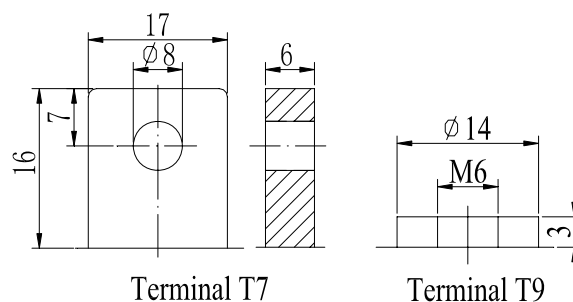

- ◆ Absorbent glass mat technology;
- ◆ Recognized by UL & CE;
- ◆ ABS container.

Constant Current Discharge Characteristics (A, 25°C)

F.V/TIME	10min	15min	30min	60min	2h	3h	4h	5h	8h	10h	20h
9.60V	69.3	54.5	33.0	20.5	12.1	8.42	6.90	5.89	4.04	3.36	1.76
9.90V	67.2	53.1	32.3	20.2	12.0	8.37	6.86	5.86	4.02	3.35	1.76
10.2V	64.4	51.2	31.4	19.6	11.9	8.31	6.81	5.82	3.99	3.34	1.76
10.5V	61.7	49.4	30.6	19.3	11.7	8.25	6.77	5.78	3.96	3.32	1.74
10.8V	58.2	46.8	29.5	18.7	11.4	8.00	6.56	5.60	3.84	3.30	1.73

Constant Power Discharge Characteristics (Watt, 25°C)

F.V/TIME	10min	15min	30min	60min	2h	3h	4h	5h	8h	10h	20h
9.60V	748	598	370	233	140	99.0	81.1	69.6	48.0	40.1	21.2
9.90V	726	584	363	230	139	98.4	80.7	69.2	47.7	40.0	21.1
10.2V	696	562	352	224	138	97.7	80.1	68.7	47.4	39.9	21.1
10.5V	666	543	343	219	136	97.0	79.6	68.3	47.0	39.7	20.9
10.8V	629	514	331	213	132	94.1	77.2	66.2	45.6	39.4	20.8

Note: The above characteristics data can be obtained within three charge/discharge cycles.

Discharge Characteristics(25°C)

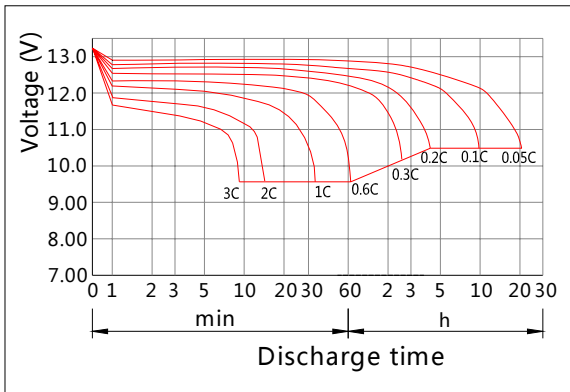

Charging Characteristics(25°C)

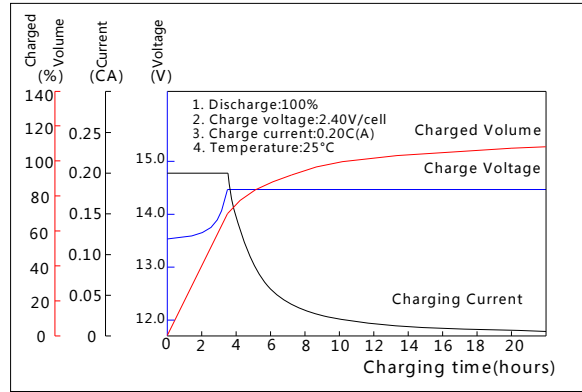

Effect of Temperature on Capacity

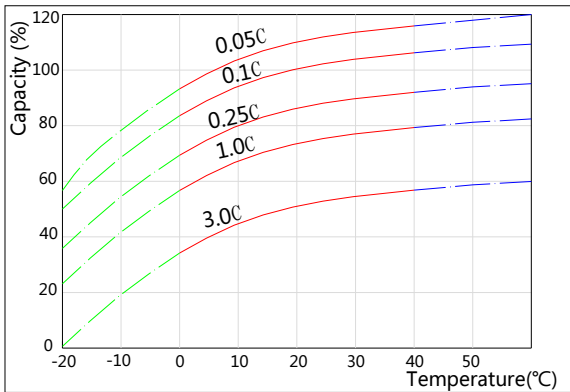

Self-discharge Characteristics

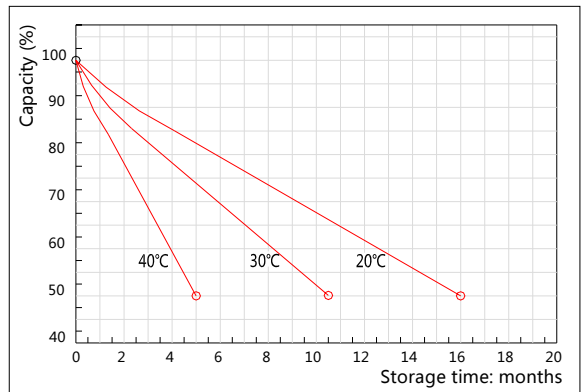

The Relationship for Open Circuit Voltage and Residual Capacity (25°C)

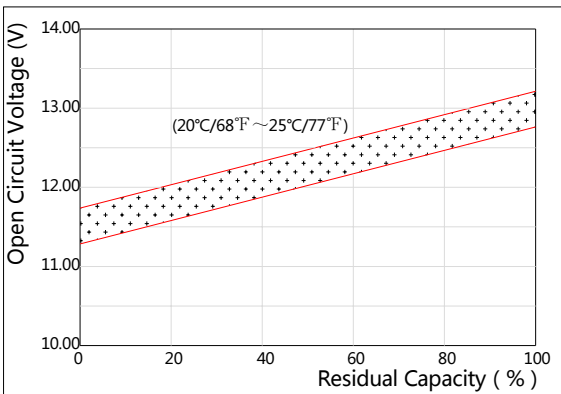

The Relationship for Charging Voltage and Temperature

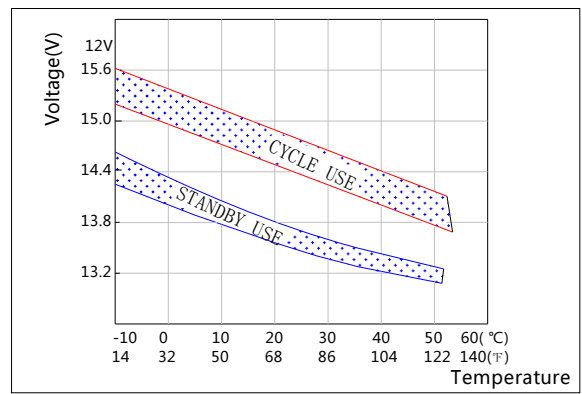

Floating Life on Temperature

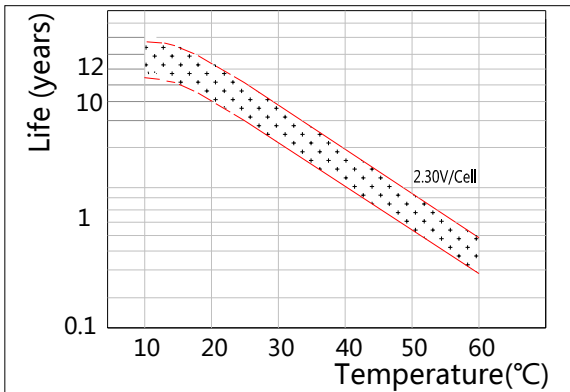

Cycle Life on D.O.D(25°C)

